

USER MANUAL



CB1000 REFLECTOMETER



Table of contents

1	Intended use	5
2	Getting started	5
	2.1 Description of the instrument	5
	2.2 Package contents	6
	2.3 Inserting the batteries	7
	2.3.1 Replacement of batteries	8
	2.3.2 Saving data – Important notes	8
	2.4 Operation buttons and display	9
	2.4.1 Operation buttons	9
	2.4.2 Display	10
	2.4.3 Menu items	10
	2.5 Starting the reflectometer the first time	11
	2.6 Settings	12
	2.6.1 Overview	13
	2.6.2 Setting the language	14
	2.6.3 Setting the date format	15
	2.6.4 Setting the time format	16
	2.6.5 Setting the date	17
	2.6.6 Setting the time	18
	2.6.7 Setting the auto power off time	19
	2.6.8 Setting the audible signal (ON or OFF)	20
	2.6.9 Setting the acoustical countdown warning	21
	2.6.10 Setting the memory capacity warning (ON or OFF)	22
	2.7 Initial calibration	23
3	Measurement	27
	Method list	27
	3.1 Add a new method	28
	3.1.1 Guided way	28
	3.1.2 Shortcut	30
	3.2 Measuring with test kits	31
	Continue with the last used method	31
	Choose from method list	31
	Shortcut	32
	Measurement procedures	33
	3.2.1 Measurement procedure A	33
	3.2.2 Measurement procedure B	35
	3.2.3 Skip the timer	39
	3.2.4 Serial measurements	39
	3.2.5 General notes on measurement	40

3.3 Method details	40
3.4 Delete all methods	42
4 Result	43
Result list	43
5 Quality assurance	46
5.1 Recalibration	46
5.1.1 Procedure	47
5.1.2 Calibration results	50
5.2 Checking the instrument	51
5.2.1 Analytical quality assurance (AQA)	51
Monitoring of the instrument	51
Total system monitoring	51
5.2.2 RQcheck procedure	52
5.2.3 RQcheck results	54
6 System information	57
7 Maintenance of the instrument	59
7.1 Handling	59
7.2 Cleaning the strip adapter	60
7.2.1 Procedure	60
8 Trouble-shooting	61
8.1 User messages on the display	61
8.2 Error messages	63
8.3 Other faults	65
9 Technical data	66
10 Accessories	67
11 Service / Warranty	68

1 Intended use

This reflectometer is intended to be used exclusively according to the operating manual. The reflectometer was developed for performing analyses of chemical parameters in water, food & beverage samples, and environmental samples using Reflectoquant® test strips in the laboratory, on the production line or in the field. Any other use is considered to be unauthorized.

2 Getting started

2.1 Description of the instrument

Your reflectometer is a versatile, precise instrument. It is part of the Reflectoquant® system with the components:

- reflectometer
- Reflectoquant® tests
- test- and batch-specific barcode strip

According to the principle of reflectometry (remission photometry), reflected light from the test strip is measured. Just as in classical photometry, the difference in intensity of emitted and reflected light allows a quantitative determination of the concentration of specific analytes.

2.2 Package contents

The standard contents of the Reflectometer package comprise the following items:

- 1 Reflectometer inclusive strip adapter,
Cat.No.1.17246.0001
- 1 Recalibration set
- 1 Quick Guide
- 4 1.5-V batteries (AAA)
- 1 Safety Instructions
- 1 ABC sample cup, 1 funnel and 1 glass measuring cylinder
- 1 box filterpaper



2.3 Inserting the batteries

Before operating the system for the first time, the batteries included in the package must be installed.



Dispose of used batteries
in accordance with the
local regulations.

1. Remove the lid of the battery compartment on the back of the instrument by pressing carefully in the indicated direction.
2. Insert the batteries into the compartment, heeding the + and – pole indicators.
3. Close the battery compartment.

2.3.1 Replacement of batteries

Refer to page 7 for how to replace used batteries.

Recommendation

Do not use rechargeable batteries!

2.3.2 Saving data - Important notes

Before changing the batteries, please shut down the instrument first.

Otherwise the date and time settings are lost.

During battery change, data in the reflectometer is saved for 60 seconds.

If the change time exceeds 60 seconds only date and time are lost, all stored data and settings are still stored.

Recommendation

Replacement batteries (AAA non-rechargeable alkaline batteries, 1.5 V) must be on hand for immediate insertion.

2.4 Operation buttons and display

2.4.1 Operation buttons

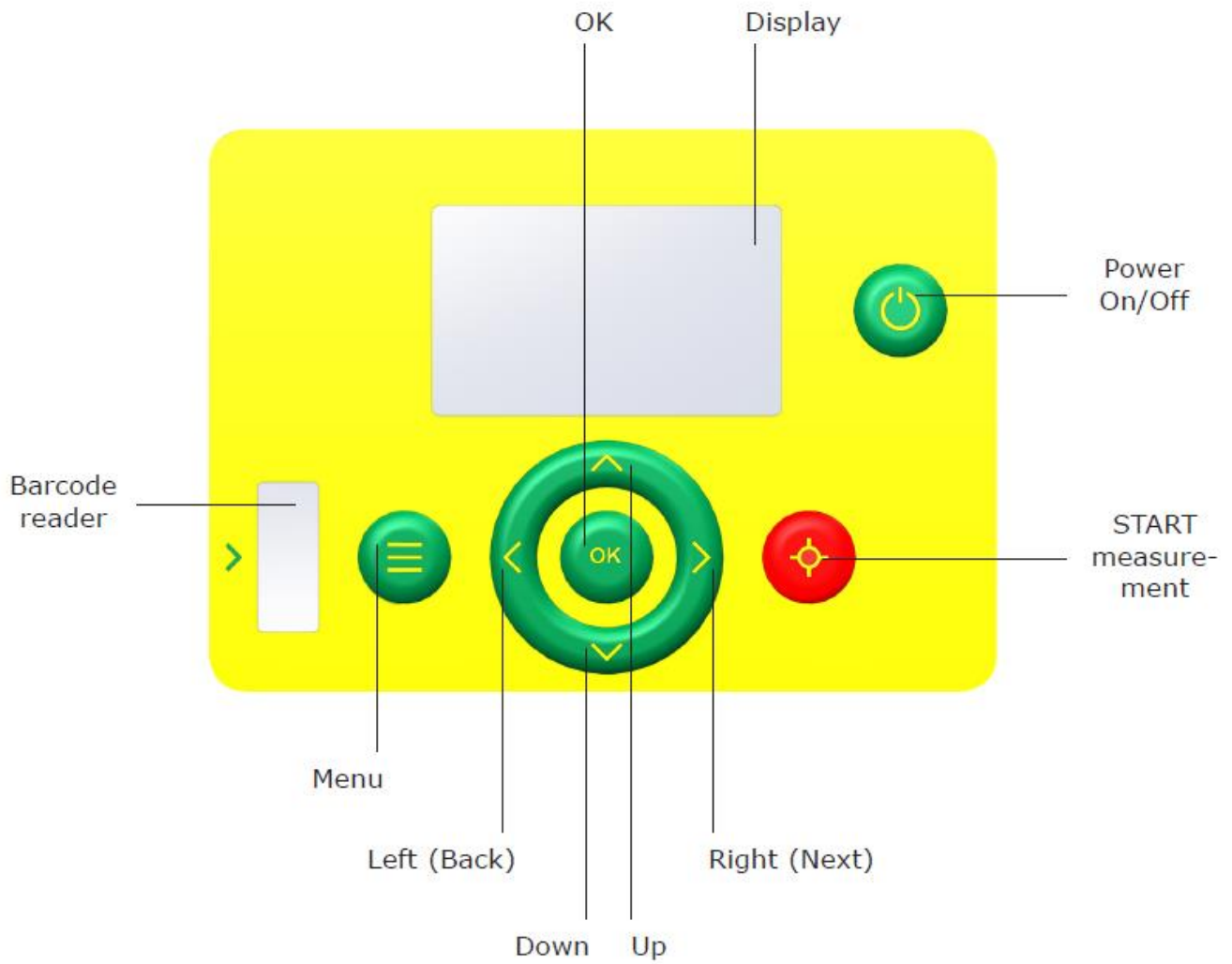

2.4.2 Display

General structure

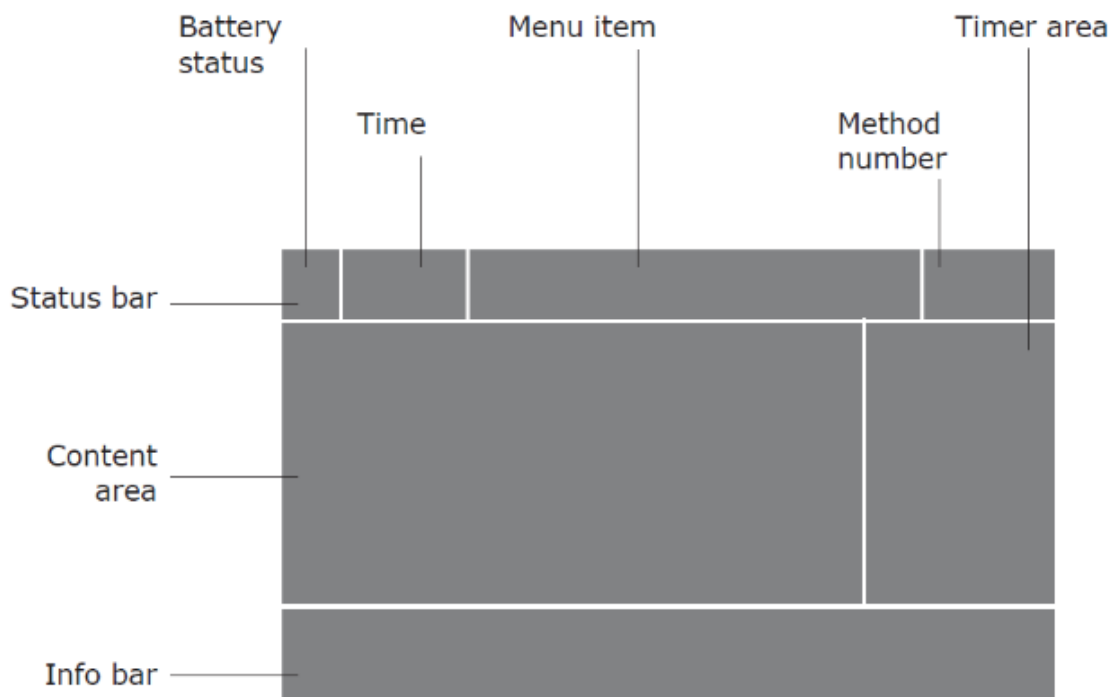

Example

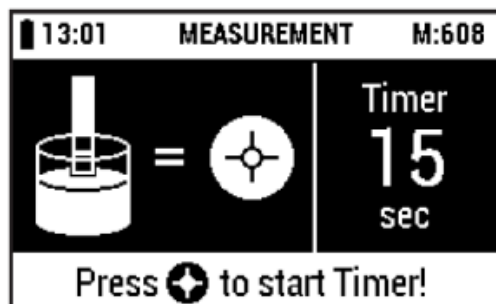

2.4.3 Menu items

The following items are displayed in the main menu:

- Method List** list of all stored methods
- Result List** list of all stored results
- Settings** list of instrument settings
- Quality Assurance** list of all Analytical Quality Assurance options
- Information** list of instrument information

2.5 Starting the meter the first time

Before working with the reflectometer insert the batteries (delivery contents). See chapter 2.3 "**Inserting the batteries**".

Switch on the reflectometer by pressing the [Power On/Off] button.

The unit runs an electronic self-check test.



The serial number of the reflectometer is displayed at the bottom right.

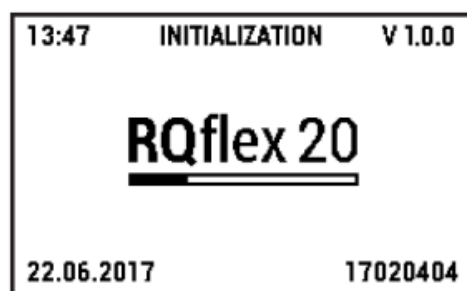

The display then shows the main menu:

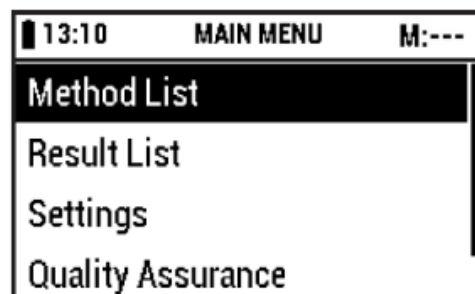

Pressing the [Up] and [Down] buttons takes the Reflectometer to the different submenus.



The Reflectometer is supplied with English preset as the standard language setting. Before making the first measurement you should therefore reset the unit to the language of your choice (see section 2.6.2, "**Setting the language**").

The date and time should be set (see sections 2.6.3 and 2.6.4, "**Setting the date and Setting the time**").

The instrument needs to be calibrated before the first measurement is performed (see section 2.7, "**Initial calibration**").

2.6 Settings

Switch on the reflectometer by pressing the [Power On/Off] button.

The unit runs an electronic self-check test.



The display then shows the main menu:

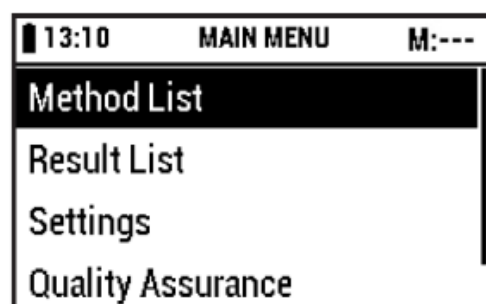

Select [**Settings**] in the [**MAIN MENU**] using the [Up] and [Down] buttons.



The display shows:

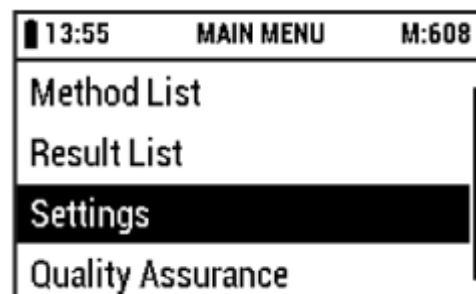

Confirm your selection by pressing [OK] or [Right (Next)].



The display shows:

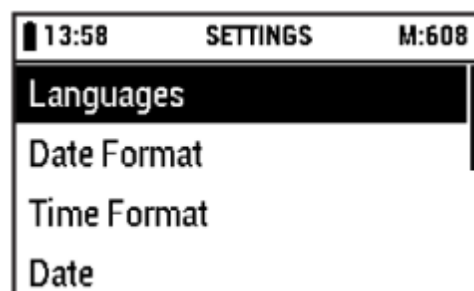

2.6.1 Overview

The following items are displayed in the settings menu:

Languages	for setting the desired language (EN - DE - FR - ES - PT - JP - CN)
Date Format	for setting the desired date format (yyyy-mm-dd - dd.mm.yyyy - mm/dd/yyyy)
Time format	for setting the desired time format (24 h - am/pm)
Date	for setting the current date
Time	for setting the current time
Auto Power Off Time	for setting the desired power off time (00 (= Off) - 15 - 30 - 45 - 60 min)
Audible Signal	for setting the audible alert (On / Off)
Acoustic. Countdown Warning	for setting the desired duration of the warning signal for the countdown (00 (= Off) - 5 - 10 - 15 - 20 - 25 - 30 sec) d
Memory Capacity Warning	for setting the memory capacity warning (On / Off)

2.6.2 Setting the language

Select [**Languages**] using the [Up] and [Down] buttons if necessary.

The display shows:

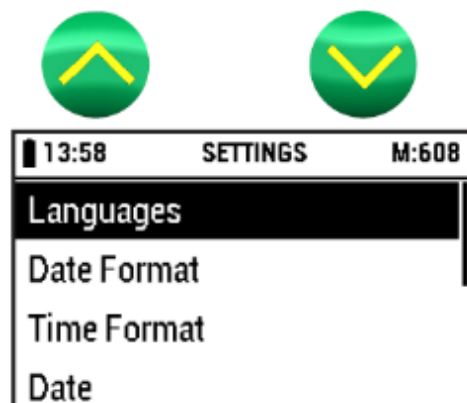

Confirm your selection by pressing [OK] or [Right (Next)].

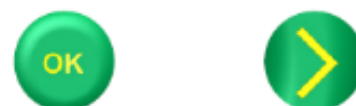

The display shows:



Select the desired language using the [Up] and [Down] buttons.



Confirm your selection by pressing [OK] or [Right (Next)] and return to [**SETTINGS**].



Press the [Left (Back)] button to return to [**MAIN MENU**].



Abort:

Press the [Left (Back)] button to abort if desired, and return to [**SETTINGS**].



2.6.3 Setting the date format

Select [**Date Format**] using the [Up] and [Down] buttons.



The display shows:

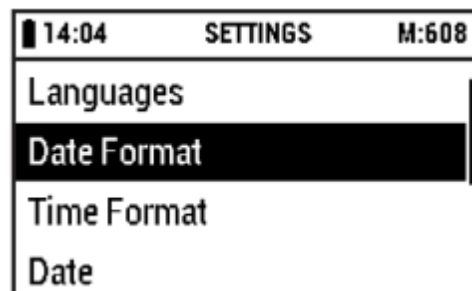

Confirm your selection by pressing [OK] or [Right (Next)].



The display shows:

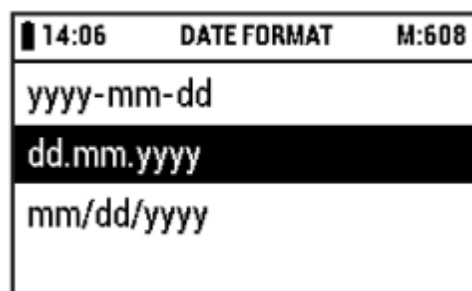

Select the desired date format using the [Up] and [Down] buttons.



Confirm your selection by pressing [OK] or [Right (Next)] and return to [**SETTINGS**].



Press the [Left (Back)] button to return to [**MAIN MENU**].



Abort:

Press the [Left (Back)] button to abort if desired, and return to [**SETTINGS**].



2.6.4 Setting the time format

Select [**Time Format**] using the [Up] and [Down] buttons.



The display shows:

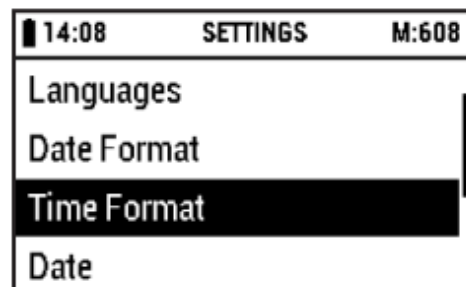

Confirm your selection by pressing [OK] or [Right (Next)].



The display shows:

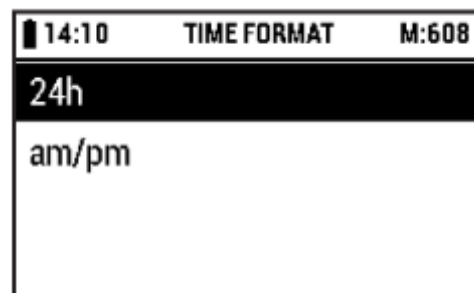

Select the desired time format using the [Up] and [Down] buttons.



Confirm your selection by pressing [OK] or [Right (Next)] and return to [**SETTINGS**].

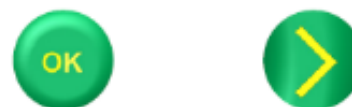

Press the [Left (Back)] button to return to [**MAIN MENU**].



Abort:

Press the [Left (Back)] button to abort if desired, and return to [**SETTINGS**].



2.6.5 Setting the date

Select [**Date**] using the [Up] and [Down] buttons.



The display shows:

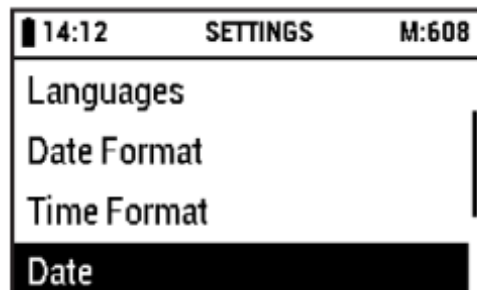

Confirm your selection by pressing [OK] or [Right (Next)].



The display shows:

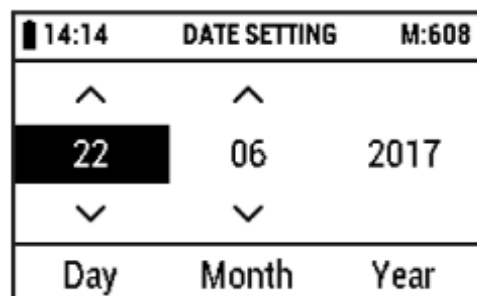

Select the desired date using the [Up] and [Down] buttons.



Change the column with the [Left (Back)] and [Right (Next)] buttons.



Confirm your selection by pressing [OK] or [Right (Next)] and return to [**SETTINGS**].



Press the [Left (Back)] button to return to [**MAIN MENU**].



Abort:

Press the [Left (Back)] button to abort if desired, and return to [**SETTINGS**].



2.6.6 Setting the time

Select [**Time**] using the [Up] and [Down] buttons.



The display shows:

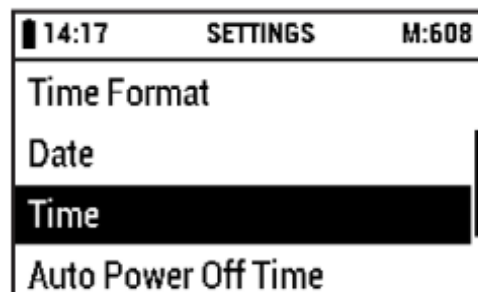

Confirm your selection by pressing [OK] or [Right (Next)].



The display shows:

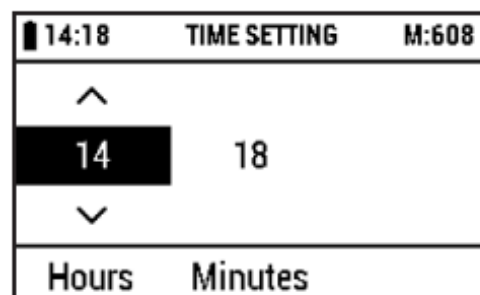

Select the desired time using the [Up] and [Down] buttons.



Change the column with the [Left (Back)] and [Right (Next)] buttons.



Confirm your selection by pressing [OK] or [Right (Next)] and return to [**SETTINGS**].



Press the [Left (Back)] button to return to [**MAIN MENU**].



Abort:

Press the [Left (Back)] button to abort if desired, and return to [**SETTINGS**].



2.6.7 Setting the power off time

Select [**Auto Power Off Time**] using the [Up] and [Down] buttons.



The display shows:

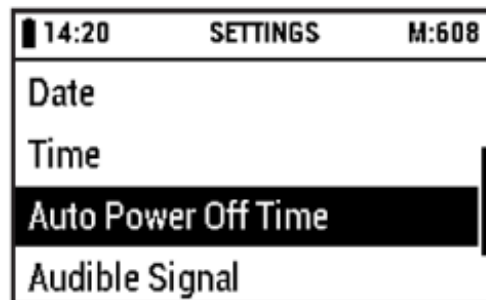

Confirm your selection by pressing [OK] or [Right (Next)].



The display shows:

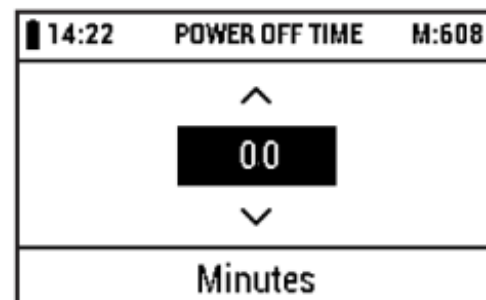

Possible selections:
(00 (= Off) - 15 - 30 - 45 - 60 min)

Select the desired auto power off time in minutes using the [Up] and [Down] buttons.



Confirm your selection by pressing [OK] or [Right (Next)] and return to [**SETTINGS**].



Press the [Left (Back)] button to return to [**MAIN MENU**].



Abort:

Press the [Left (Back)] button to abort if desired, and return to [**SETTINGS**].



2.6.8 Setting the audible signal (ON or OFF)

Select [**Audible Signal**] using the [Up] and [Down] buttons.



The display shows:

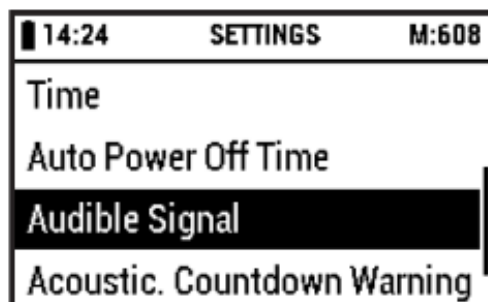

Confirm your selection by pressing [OK] or [Right (Next)].



The display shows:

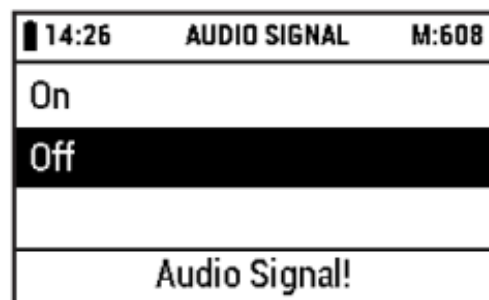

Select the desired audible alert using the [Up] and [Down] buttons.



Confirm your selection by pressing [OK] or [Right (Next)] and return to [**SETTINGS**].



Press the [Left (Back)] button to return to [**MAIN MENU**].



Abort:

Press the [Left (Back)] button to abort if desired, and return to [**SETTINGS**].



2.6.9 Setting the acoustical countdown warning

Select [**Acoustic. Countdown Warning**] using the [Up] and [Down] buttons.



The display shows:

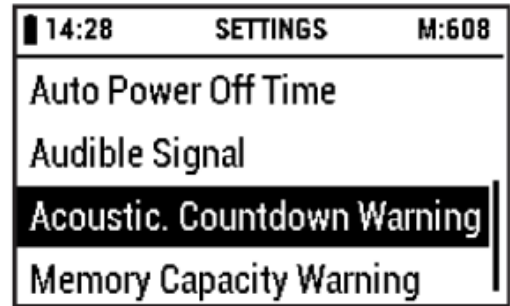

Confirm your selection by pressing [OK] or [Right (Next)].



The display shows:



Possible selections:

(00 (= Off) – 5 – 10 – 15 – 20 – 25 – 30 sec)

Select the desired duration of the warning signal in seconds using the [Up] and [Down] buttons.



Confirm your selection by pressing [OK] or [Right (Next)] and return to [**SETTINGS**].



Press the [Left (Back)] button to return to [**MAIN MENU**].



Abort:

Press the [Left (Back)] button to abort if desired, and return to [**SETTINGS**].



2.6.10 Setting the memory capacity warning (ON or OFF)

Select [**Memory Capacity Warning**] using the [Up] and [Down] buttons.

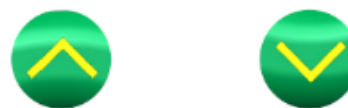

The display shows:

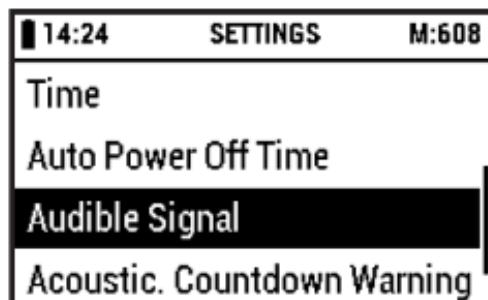

Confirm your selection by pressing [OK] or [Right (Next)].



The display shows:

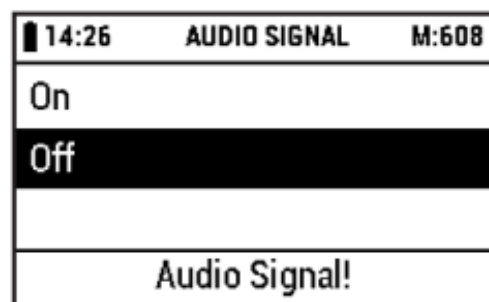

Select the desired memory space warning mode (On or OFF) using the [Up] and [Down] buttons.



Confirm your selection by pressing [OK] or [Right (Next)] and return to [**SETTINGS**].



Press the [Left (Back)] button to return to [**MAIN MENU**].



Abort:

Press the [Left (Back)] button to abort if desired, and return to [**SETTINGS**].



2.7 Initial calibration

The instrument needs to be calibrated before the first measurement is performed. This is required to set the correct baseline for the reflectometric optics. For this purpose, a Reflectoquant® Recalibration Set is delivered with the instrument. Please use the barcode and the plastic test strip for calibration (for details of the Recalibration Set see section 5, "**Quality assurance**").

Keep the instrument at room temperature for at least 30 minutes.

Switch on the reflectometer by pressing the [Power On/Off] button.

The unit runs an electronic self-check test.



The display then shows the main menu:

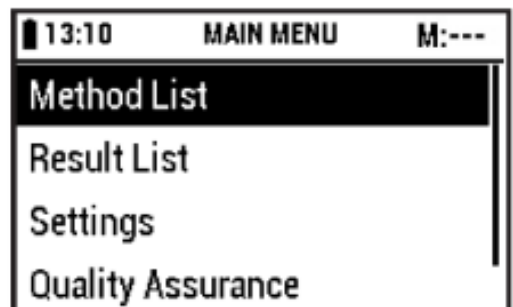

Select [**Quality Assurance**] in the [**MAIN MENU**] using the [Up] and [Down] buttons.



The display shows:

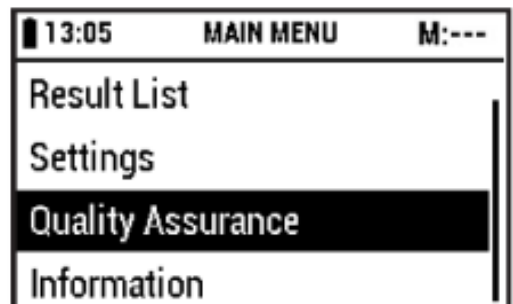

Confirm your selection by pressing [OK] or [Right (Next)].



The display shows:

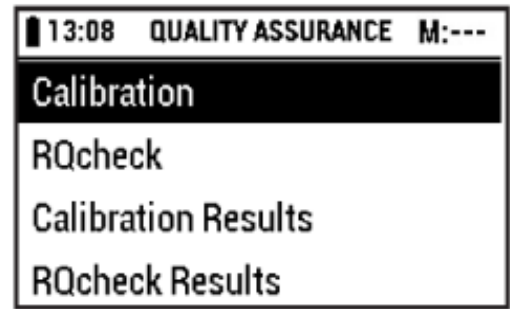

Pressing the [Left (Back)] button takes you back to [MAIN MENU].



Select [**Calibration**] using the [Up] and [Down] buttons if necessary.



The display shows:

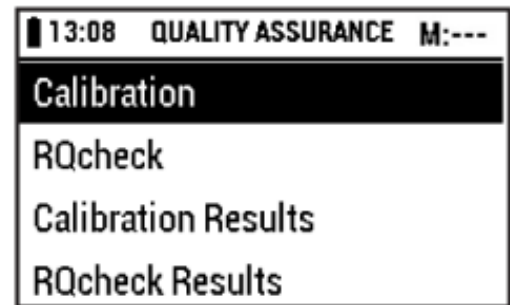

Confirm your selection by pressing [OK] or [Right (Next)].



The display shows:

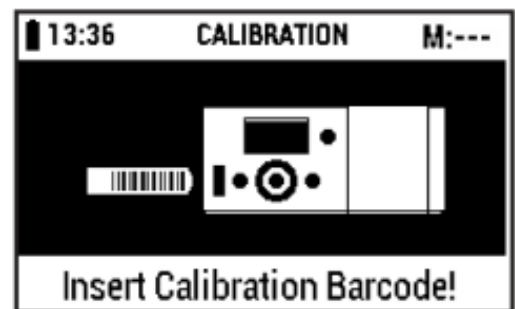

Remove the barcode strip for calibration from the pack (included in the scope of delivery of reflectometer). Insert the barcode all the way into the barcode reader in the direction of the arrow in a smooth motion from left to right, and then remove it again.



The display shows:

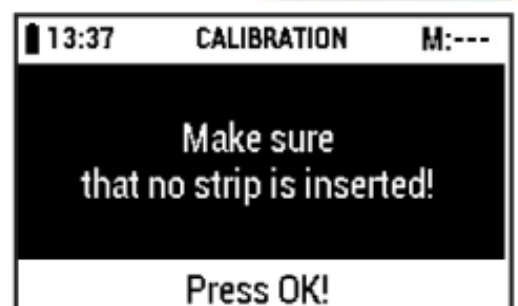

Make sure that no test strip is inserted in the test strip adapter, then press [OK].

The display shows:

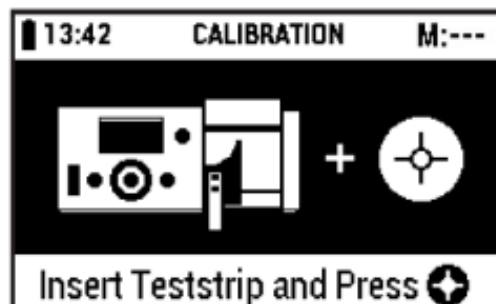

Insert the calibration strip of the recalibration set

(included in the scope of delivery of reflectometer) into the strip adapter with the beveled edge outwards and upwards and press the [START measurement] button.



The calibration is carried out.

The display shows:

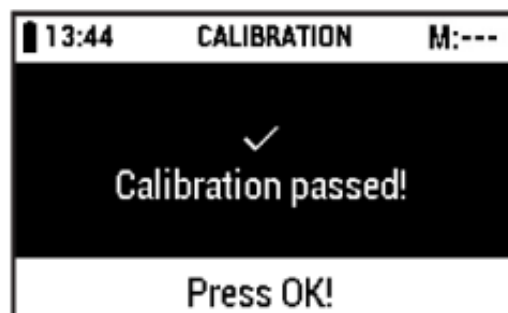

Pressing the [OK] button leads you forward to [Calibration Results] (see "Calibration Results", 5.1.2).

Abort: For abort press the [Menu] button.



The display shows:

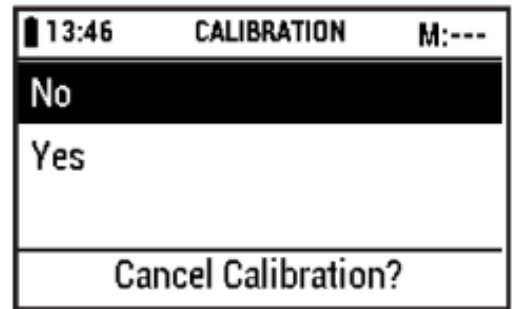

Select the desired action using the [Up] and [Down] buttons:



No: return to [**CALIBRATION**]

Yes: return to [**QUALITY ASSURANCE**]

Confirm your selection by pressing [OK] or [Right (Next)].



3 Measurement

Method list

Switch on the reflectometer by pressing the [Power On/Off] button.



The unit runs an electronic self-check test.



The display then shows the main menu:

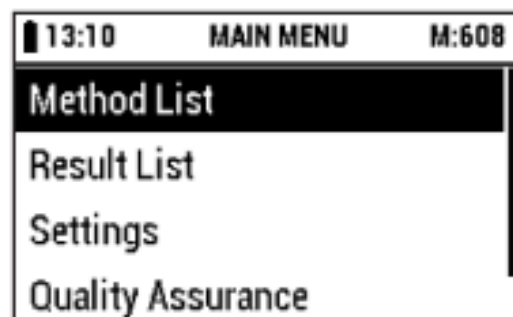

Press [START measurement] button to return to the last used method

or

select [**Method List**] in the [**MAIN MENU**] using the [Up] and [Down] buttons if necessary.



The display shows:

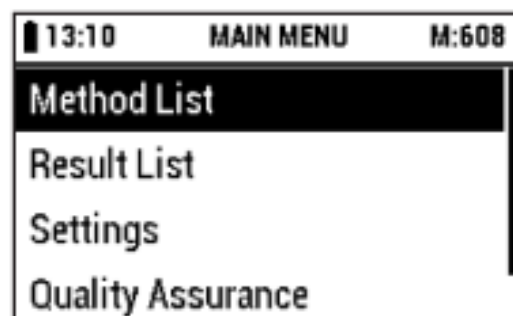

Confirm your selection by pressing [OK] or [Right (Next)].



The display shows for example:

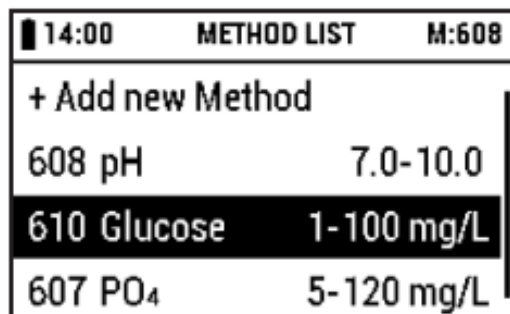

Pressing the [Left (Back)] button takes you back to [MAIN MENU].

3.1 Add a new method

There are two scenarios for adding a method:

1. Guided way
2. Shortcut

3.1.1 Guided way

Select [**Add new Method**] in the [**METHOD LIST**] using the [Up] and [Down] buttons.

The display shows:

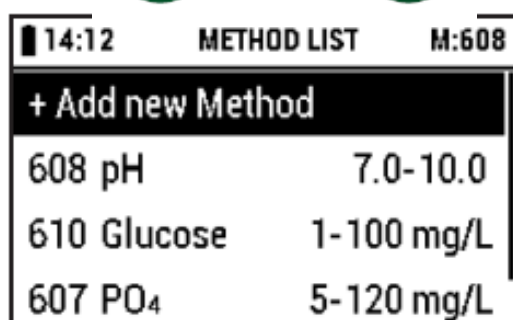

Confirm your selection by pressing [OK] or [Right (Next)].

The display shows:

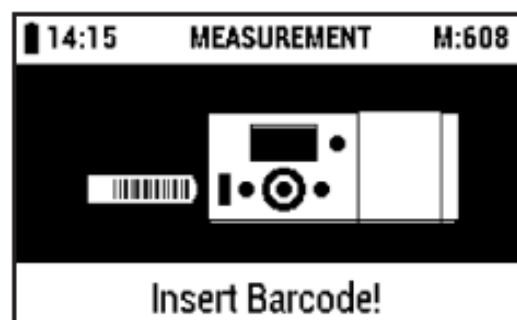

Remove the specific barcode strip from the Reflectoquant® pack. Certain tests require two barcode strips.

Insert the barcode all the way into the barcode scanner in the direction of the arrow in a smooth motion from left to right, and then remove it again.



In the case of requiring two barcode strips the display shows now:

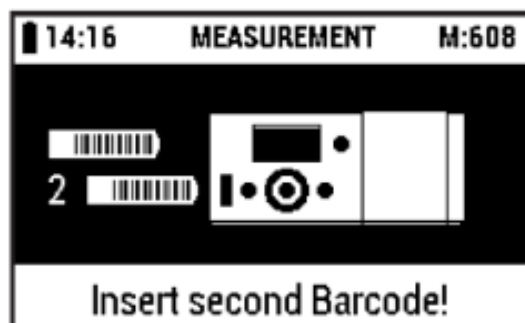

Insert the second barcode the same way before.

Adding a new method is successfully finished when the display shows:



Press [OK].



Store the barcode strip in the supplied packaging material of the Reflectoquant® test (not in the test-strip tube).

The display shows the new added method in the first row. The first number corresponds to the code number of the barcode strip resp. the first three digits of the batch number of the Reflectoquant® pack:

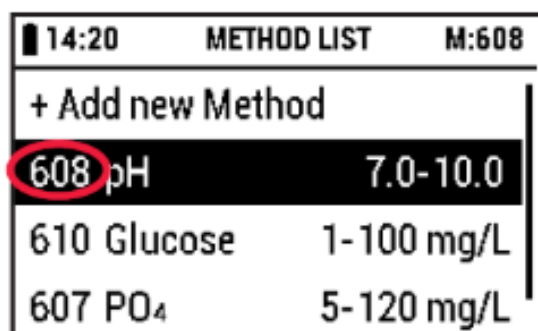

Abort:

For abort press the [Menu] button.



The display shows:

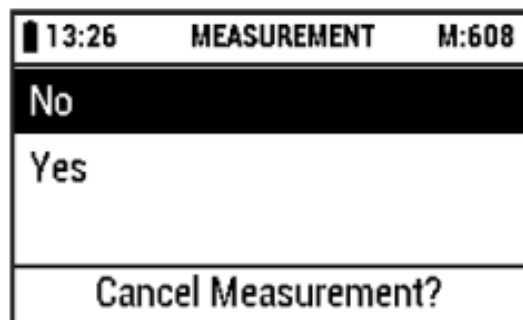

Select the desired action using the [Up] and [Down] buttons:



No: return to [**Insert Barcode!**]

Yes: return to [**METHOD LIST**]

Confirm your selection by pressing [OK] or [Right (Next)].



3.1.2 Shortcut

A method can be started directly at any menu item by inserting the barcode strip of the Reflectoquant® test.

Follow the instruction in the package insert of the corresponding Reflectoquant® test, e.g. "Preparation", "Procedure".

3.2 Measuring with test kits

There are three ways to measure with test kits:

1. Continue with last used method
2. Choose from method list
3. Shortcut

Continue with last used method

The method number shows the last used method, measurement is started immediately after pressing the red [START measurement] button.

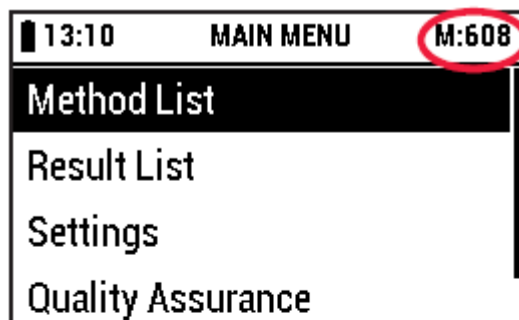

Choose from method list

If another stored method is needed, select [Method List] in the [MAIN MENU] using the [Up] and [Down] buttons.

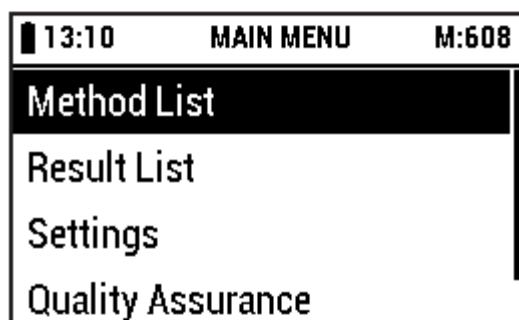

Confirm your selection by pressing [OK] or [Right (Next)].

The display shows:

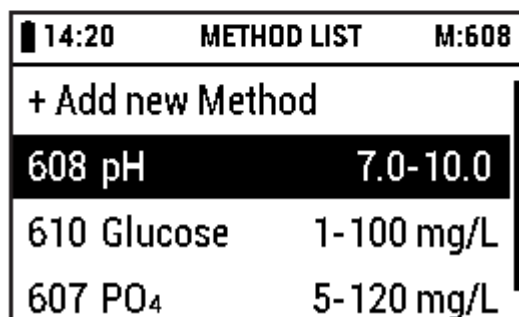

Select the desired method using the [Up] and [Down] buttons.

Confirm by pressing the [START measurement] button

and follow the instruction in the package insert of the corresponding Reflectoquant® test, e.g. "Preparation", "Procedure".

Shortcut

A method can be started directly at any menu item by inserting the barcode strip of the Reflectoquant® test.

Follow the instruction in the package insert of the corresponding Reflectoquant® test, e.g. "Preparation", "Procedure".

Measurement procedures

There are two distinct measurement procedures. The both procedures are very similar and differ only in the first steps. Each measurement procedure is test-specific. The procedure is transferred to the instrument via the barcode strip. All steps involved to obtain the result are displayed on the screen. Please also refer to the respective Reflectoquant® package insert!

3.2.1 Measurement procedure A

This procedure has only **one** reaction time.

For choosing the right method compare the first three digits of the batch number of the Reflectoquant® pack. This reference number must be the same as the one displayed. If not, perform a method calibration (see section 3.2, "**Add a new method**").

14:20	METHOD LIST	M:608
+ Add new Method		
608	pH	7.0-10.0
610	Glucose	1-100 mg/L
607	PO ₄	5-120 mg/L



Confirm your selection by pressing [START measurement]



The display shows for example:

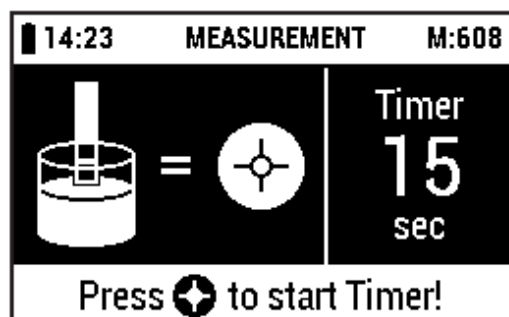

Immerse the test strip into the sample as described in the Reflectoquant® package insert (Reflectoquant® pack) and **at the same time** press the [START measurement] button to start the timer.

Carefully allow excess liquid to run off via the long edge of the strip onto an absorbent paper towel. If the countdown function of the instrument is activated, the remaining reaction time is shown (countdown).

Note

You can perform the measurement immediately by pressing the [START measurement] button again to skip the countdown. In this case the strip must be inserted into the strip adapter. To repeat a measurement e.g. when the test strip was inserted incorrectly or too late.

An acoustic signal (if warning signal is set > 0 sec, see section 2.6.9, "**Setting the acoustical countdown warning**") starts before the end of the reaction time requests you to insert the strip all the way into the strip adapter. The strip can also be inserted before the warning signal time have expired (see the corresponding package insert).

The measurement starts automatically after the end of the reaction time. The measurement result is displayed and automatically stored.

The save hint is shown only if memory space warning is on (see section 2.9.10, "**Setting the memory capacity warning**").

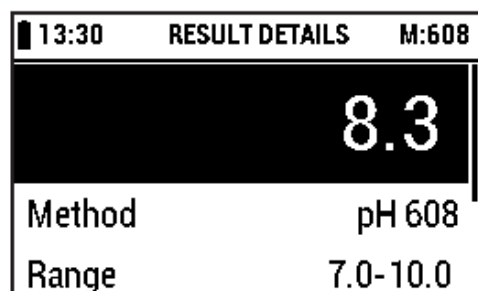
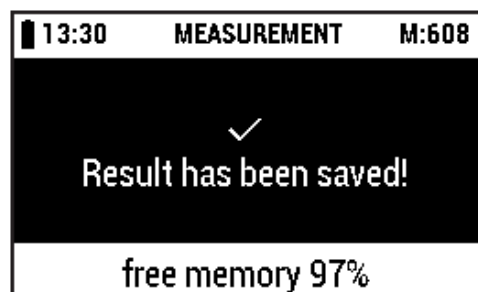
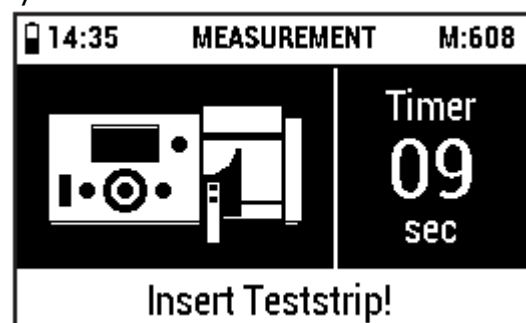
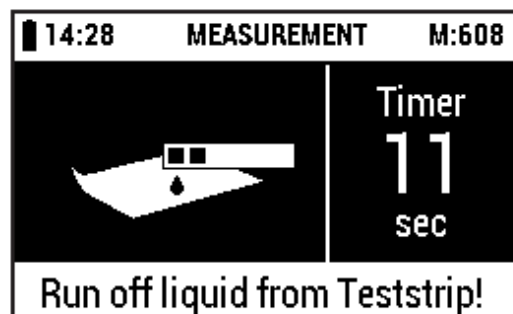

Abort: For abort press the [Menu] button.

The display shows:

Select the desired action using the [Up] and [Down] buttons:



No: return to [**MEASUREMENT**]

Yes: return to [**METHOD LIST**]

Confirm your selection by pressing [OK] or [Right (Next)].



3.2.2 Measurement procedure B

Besides the reaction time of the Reflectoquant® tests this procedure also considers other waiting times.

For choosing the right method compare the first three digits of the batch number of the Reflectoquant® pack. This reference number must be the same as the one displayed. If not, perform a method calibration (see section 3.2, "**Add a new method**").

14:50	METHOD LIST	M:520
+ Add new Method		
520 K	0.25-1.20 g/L	
X Delete all Methods		

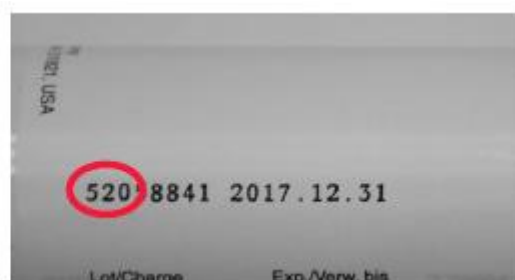

Confirm your selection by pressing [START measurement].



The display shows:

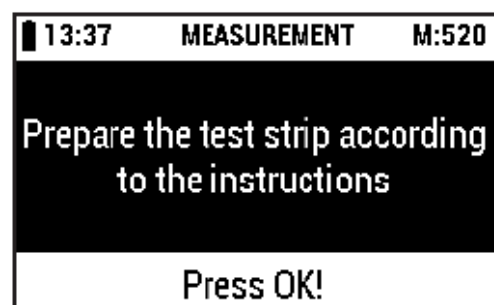

Immerse the test strip into the sample as described in the Reflectoquant® package insert (Reflectoquant® pack) and press the [OK] button.



Carefully allow excess liquid to run off via the long edge of the strip onto an absorbent paper towel and press the [OK] button.

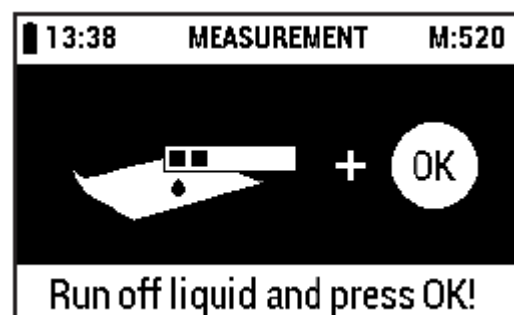

Immerse the test strip into the corresponding solution as described in the Reflectoquant® package insert (Reflectoquant® pack) and **at the same time** press the [OK] button to start the timer.

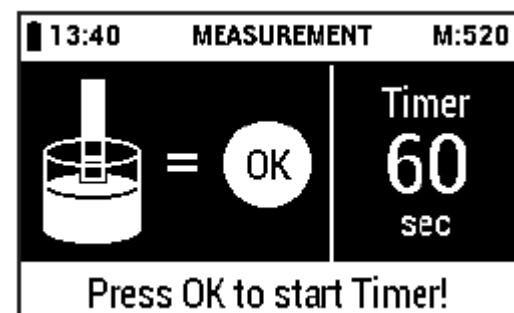

The display shows for example:

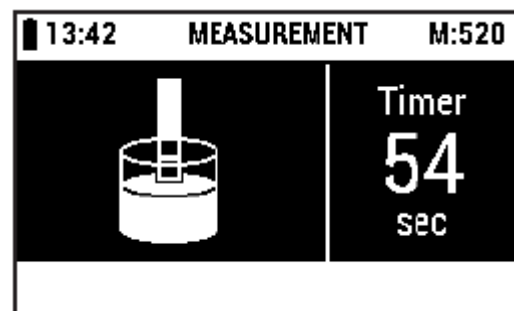

After the reaction time the display shows



Carefully allow excess liquid to run off via the long edge of the strip onto an absorbent paper towel and press the [OK] button.



The display shows:

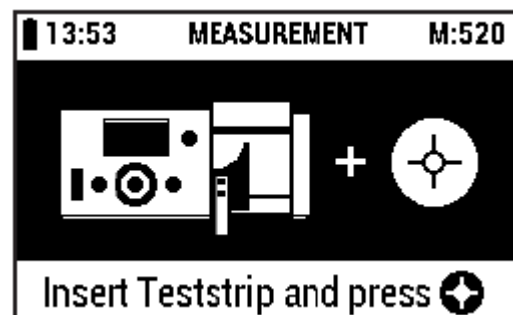

Insert the test strip into the test strip adapter and press the [START measurement] button.



The display shows for example:

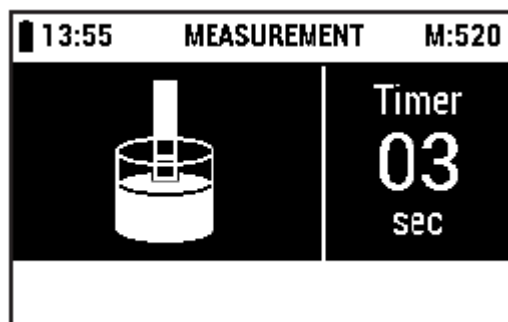

The measurement starts automatically after the end of the reaction time.

The measurement result is displayed and automatically stored.

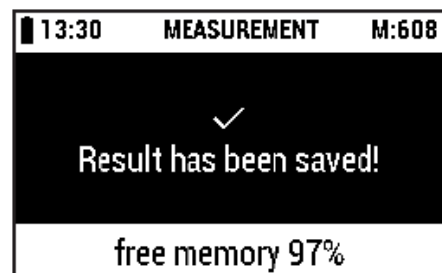

The save hint is shown only if memory space warning is on (see section 2.9.10, "**Setting the memory capacity warning**").

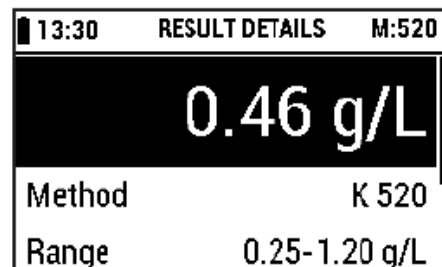

Abort:

For abort press the [Menu] button.



The display shows:

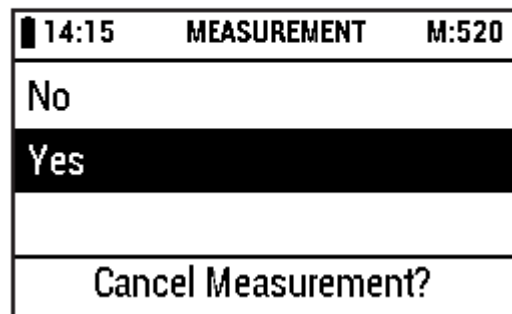

Select the desired action using the [Up] and [Down] buttons:



No: return to [MEASUREMENT]

Yes: return to [METHOD LIST]

Confirm your selection by pressing [OK] or [Right (Next)].



3.2.3 Skip the timer

It is possible to interrupt the timer, to perform measurements directly without the countdown function of the instrument. The timer function can be skipped by pressing the [START measurement] button again while the timer is running. The instrument makes the measurement immediately. The result is displayed and automatically stored. Always make sure that the reaction time of the test method is met, e.g. with an external stopwatch.



3.2.4 Serial measurements

It is possible to skip the timer, to perform measurements directly without the countdown function of the instrument.

Once the first measurement has been completed, a further measurement can be carried out simply by pressing the [START measurement] button. In all these cases the instrument makes the measurements immediately.



If you wish to measure e.g. several nitrate samples, it is advisable to follow the procedure below. For repeat serial measurement the countdown function is not available and an additional stopwatch is needed.

Run the standard measurement (procedure A) once.

Immerse separate test strips into your sample at e.g. 15-second intervals. Carefully allow excess liquid to run off via the long edge of the strip onto an absorbent paper towel and allow each strip to react outside the instrument.

After completion of the reaction time (e.g. 60 sec) of the first test strip insert each strip into the instrument in e.g. 15-second intervals. Press the [START measurement] button to perform the measurement.



The results are stored automatically.

3.2.5 General notes on measurement

Don't change ambient temperatures during ongoing sample measurements. If the instrument is taken to other temperature conditions start the test methods anew to reset the internal standard value.

3.3 Method details

Here you can see the details of the chosen method.

Select the desired method using the [Up] and [Down] buttons:



The display shows:

14:20	METHOD LIST	M:520
+ Add new Method		
608 pH	7.0-10.0	
610 Glucose	1-100 mg/L	
607 PO ₄	5-120 mg/L	

Confirm your selection by pressing [OK] or [Right (Next)].



The display shows for example:

14:20	METHOD LIST	M:520
Article Number 1.16898.0001		
Method	pH 608	
Range	7.0-10.0	
X Delete Method		

Pressing the [START measurement] button leads you forward to [MEASUREMENT] of the chosen method.



Pressing the [Left (Back)] button takes you back to [METHOD LIST].



For deletion the chosen method, select **[X Delete Method]** using the [Up] and [Down] buttons.

Confirm your selection by pressing [OK] or [Right (Next)].



The display shows:

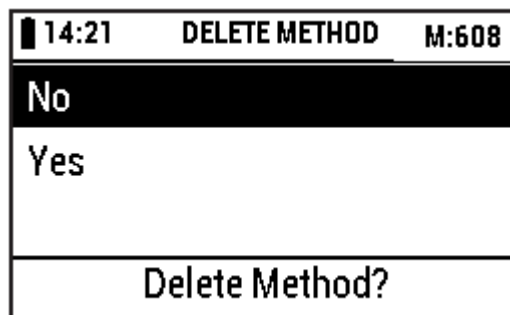

Select the desired action using the [Up] and [Down] buttons:



No: return to **[METHOD DETAIL]**

Yes: delete the method and return to **[METHOD LIST]**

Confirm your selection by pressing [OK] or [Right (Next)].



3.4 Delete all methods

Select the desired method using the [Up] and [Down] buttons:



The display shows:

14:23	METHOD LIST	M:520
608	pH	7.0-10.0
610	Glucose	1-100 mg/L
607	PO ₄	5-120 mg/L
X Delete all Methods		

Confirm your selection by pressing [OK] or [Right (Next)].

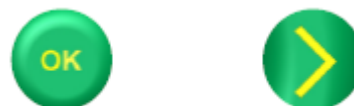

The display shows:

14:25	DELETE ALL METHODS	M:520
No		
Yes		
Delete all Methods?		

Select the desired action using the [Up] and [Down] buttons:



No: return to [METHOD LIST]

Yes: delete all methods and return to [METHOD LIST]

Confirm your selection by pressing [OK] or [Right (Next)].



4 Results

Result list

Switch on the reflectometer by pressing the [Power On/Off] button.



The unit runs an electronic self-check test.

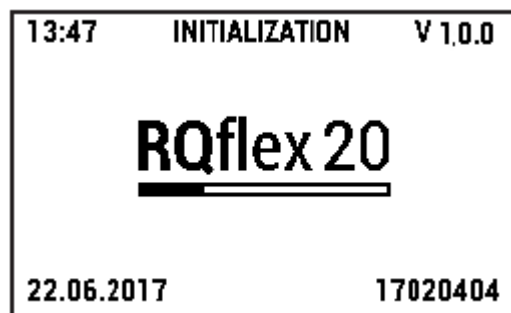

The display then shows the main menu:

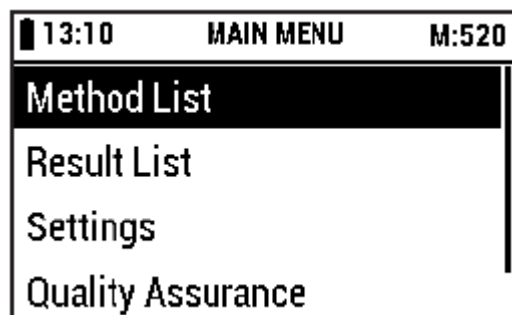

Select [**Result List**] in the [**MAIN MENU**] using the [Up] and [Down] buttons.



The display shows:

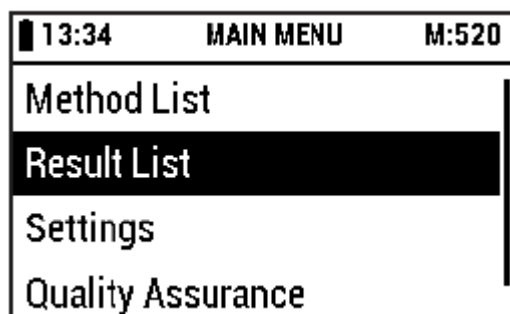

Confirm your selection by pressing [OK] or [Right (Next)].



The display shows all results which are stored in the instrument:

13:36	RESULT LIST	M:520
22.06.2017 14:12		
0.45 g/L		K 520
0.45 g/L		K 520
0.45 g/L		K 520

Pressing the [Left (Back)] button takes you back to [MAIN MENU].



For details, select the desired method using the [Up] and [Down] buttons.



Confirm your selection by pressing [OK] or [Right (Next)].



The display shows for example:

13:39	RESULT DETAILS	M:520
0.45 g/L		
Method		K 520
Range		0.25-1.20 g/L

Pressing the [Left (Back)] button takes you back to [RESULT LIST].



For deletion the results of the chosen method, select [X Delete Result] using the [Up] and [Down] buttons.



Confirm your selection by pressing [OK] or [Right (Next)].



The display shows:

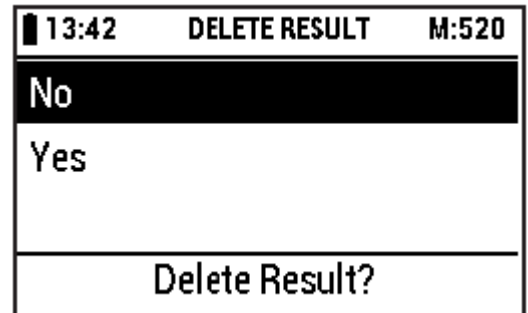

Select the desired action using the [Up] and [Down] buttons:



No: return to [**RESULT DETAILS**]

Yes: delete the result and return to [**RESULT LIST**]

Confirm your selection by pressing [OK] or [Right (Next)].



5 Quality assurance

5.1 Recalibration

The recalibration set consists of an internal standard (light grey plastic component), a barcode strip for calibration, and a white calibration strip.

A recalibration has to be performed

- after the first start (see section 2.7, "**Initial calibration**")
- after changing/cleaning of the strip adapter and/or the internal standard
- in the case of suspect measurement results during the boot up (self-check test failed)
- in the case of error messages E07 or E10 (after cleaning the optics)
- in the case of RQCheck failure (error messages E09 and E11)
- in the case of suspect measurement results
- after severe mechanical distress (e. g. after dropping the instrument)
- after changing the ambient temperature
- each working day

5.1.1 Procedure

If necessary clean the strip adapter thoroughly (see section 7.2, "**Cleaning the strip adapter**").

Take care that the internal standard has not changed color (if necessary exchange the internal standard, Strip adapter, Cat. No. 1.16953.0001).

Keep the instrument at ambient temperature for at least 30 minutes.

Insert the adapter and switch on the reflectometer by pressing the [Power On/Off] button. The unit runs an electronic self-check test.

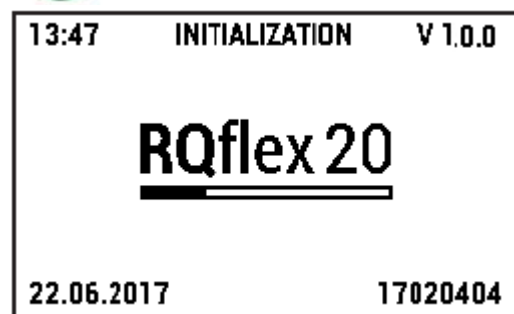

The display then shows the main menu:

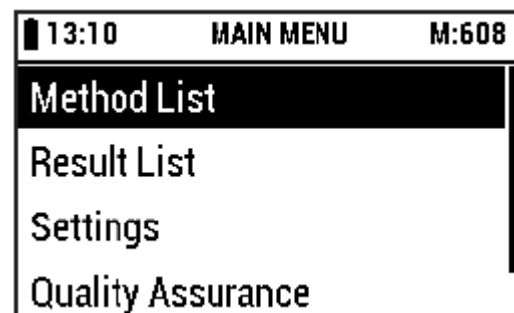

Select [**Quality Assurance**] in the [**MAIN MENU**] using the [Up] and [Down] buttons.



The display shows:

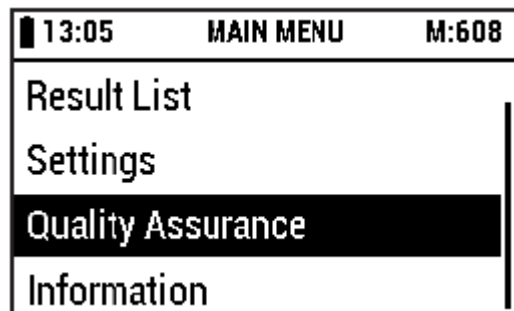

Confirm your selection by pressing [OK] or [Right (Next)].



The display shows:

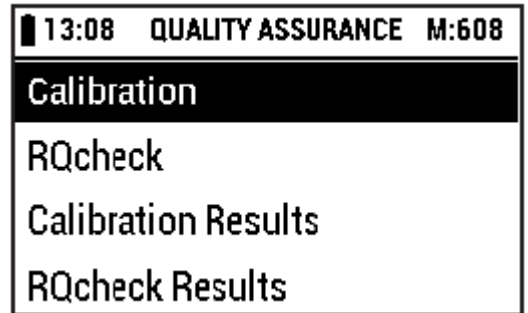

Pressing the [Left (Back)] button takes you back to [MAIN MENU].



Select [**Calibration**] using the [Up] and [Down] buttons.



The display shows:

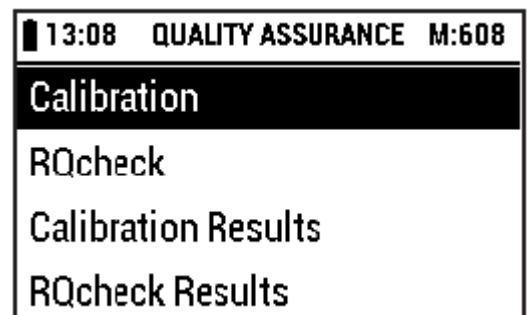

Confirm your selection by pressing [OK] or [Right (Next)].



The display shows:

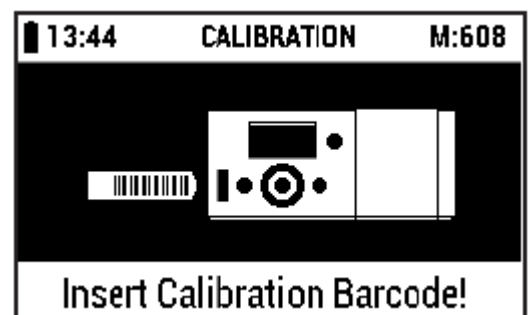

Remove the barcode strip for calibration from the pack (included in the scope of delivery of reflectometer). Insert the barcode all the way into the barcode reader in the direction of the arrow in a smooth motion from left to right, and then remove it again.



Make sure that no test strip is inserted in the test strip adapter, then press [OK].

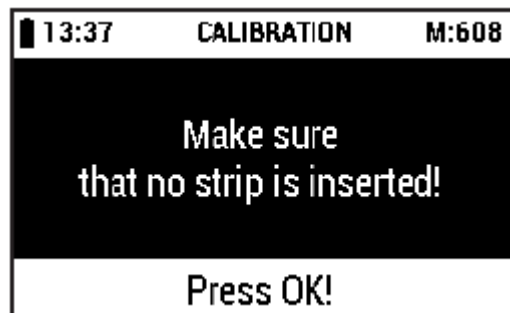

The display shows:

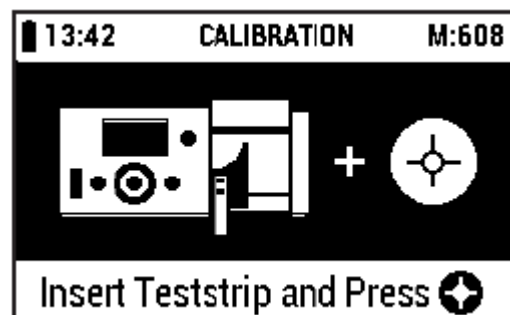

Insert the calibration strip of the recalibration set (included in the scope of delivery of reflectometer) into the strip adapter with the beveled edge outwards and upwards and press the [START measurement] button.



The calibration is carried out.
The display shows:

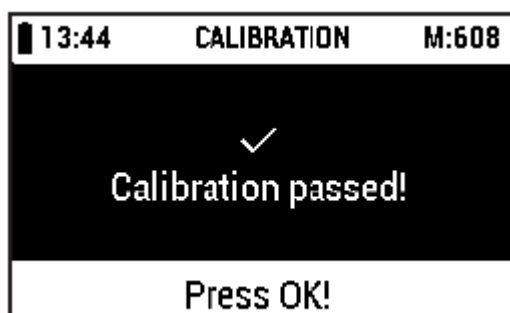

Pressing the [OK] button leads you forward to [Calibration Results] (see „Calibration Results“, 5.1.2).



Abort: For abort press the [Menu] button.

The display shows:

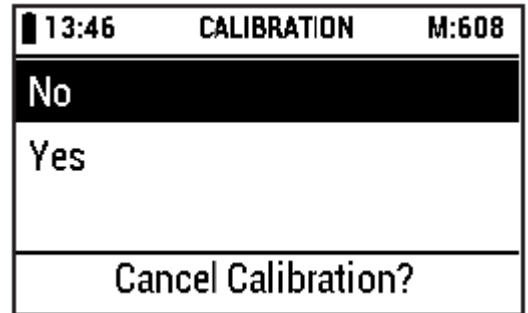

Select the desired action using the [Up] and [Down] buttons:



No: return to [**CALIBRATION**]

Yes: return to [**QUALITY ASSURANCE**]

Confirm your selection by pressing [OK] or [Right (Next)].



5.1.2 Calibration results

Select [**Calibration Results**] using the [Up] and [Down] buttons.



The display shows:

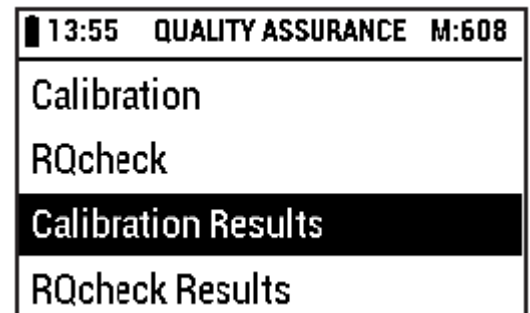

Confirm your selection by pressing [OK] or [Right (Next)].



The display shows all calibration data which are stored in the instrument:

first column: running number

second column: date of calibration

Running number	Date of calibration
0008	22.06.2017
0007	22.06.2017
0006	22.06.2017
0005	22.06.2017

Pressing the [Left (Back)] button takes you back to [**QUALITY ASSURANCE**].



5.2 Checking the instrument

5.2.1 Analytical quality assurance (AQA)

The objective of analytical quality assurance (AQA) is to secure correct and precise measurement results.

Analytical quality assurance (AQA) can be carried out in two steps independent of each other:

- **AQA1:** Monitoring of the instrument
- **TSM:** Monitoring of the total system

TSM covers the instrument, the test that is used, the accessories, and the user's way of working.

Monitoring of the instrument (AQA1)

The RQcheck is required for the instrument monitoring (see section 5.2.2, "**RQcheck procedure**").

Total system monitoring (TSM)

For total system monitoring, standard solutions with a defined analyte content are required. Please see further instructions in section "**Method control**" of the package insert of the respective Reflectoquant® test.

5.2.2 RQcheck procedure

Select [**RQcheck**] using the [Up] and [Down] buttons.



The display shows:

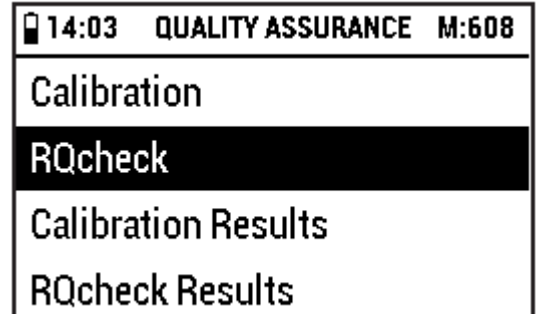

Confirm your selection by pressing [OK] or [Right (Next)].



The display shows:

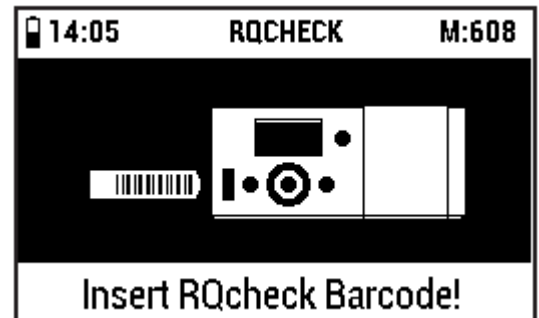

Remove the barcode strip for RQcheck from the pack. Insert the barcode all the way into the barcode reader in the direction of the arrow in a smooth motion from left to right, and then remove it again.



Insert the test strip for RQcheck into the test strip Adapter and press the [START measurement] button.

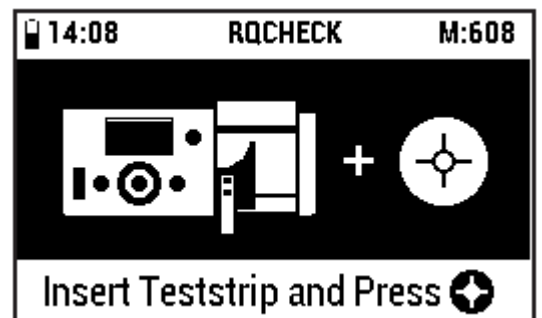

The measurement is carried out.

The display shows for aprox. 1 second:

The save hint is shown only if memory space warning is on (see section 2.9.10, "**Setting the memory capacity warning**").

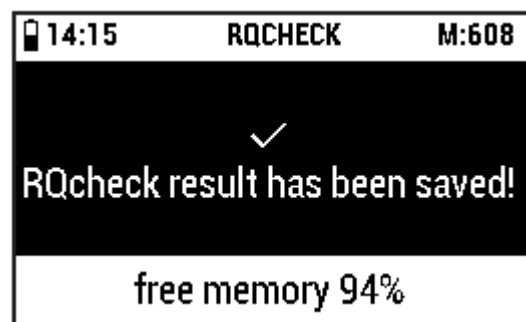

Then the display shows:



Pressing the [OK] button leads you forward to [RQcheck Results].



Abort: For abort press the [Menu] button.



The display shows:

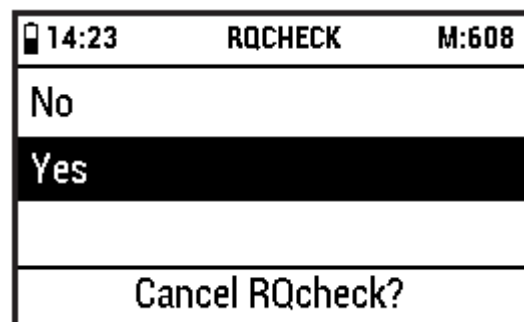

Select the desired action using the [Up] and [Down] buttons:



No: return to [RQCHECK]

Yes: return to [QUALITY ASSURANCE]

Confirm your selection by pressing [OK] or [Right (Next)].



5.2.3 RQcheck results

Select [**RQcheck Results**] using the [Up] and [Down] buttons.

The display shows:

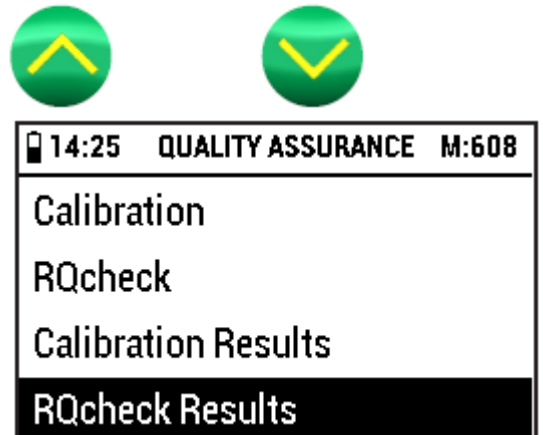

Confirm your selection by pressing [OK] or [Right (Next)].

The display shows all RQcheck results which are stored in the instrument:

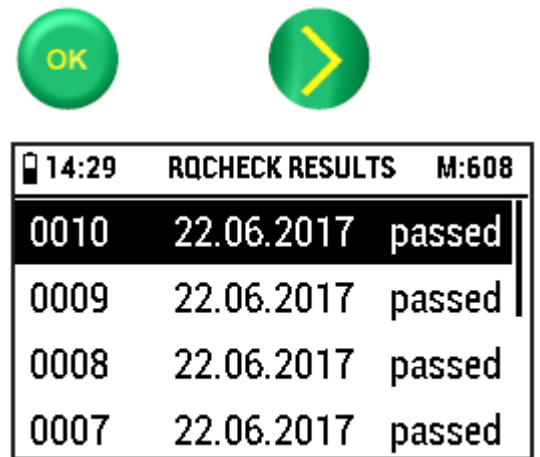

Select the desired RQcheck result using the [Up] and [Down] buttons:

Confirm your selection by pressing [OK] or [Right (Next)].

Pressing the [Left (Back)] button takes you back to [**QUALITY ASSURANCE**].

The display shows:

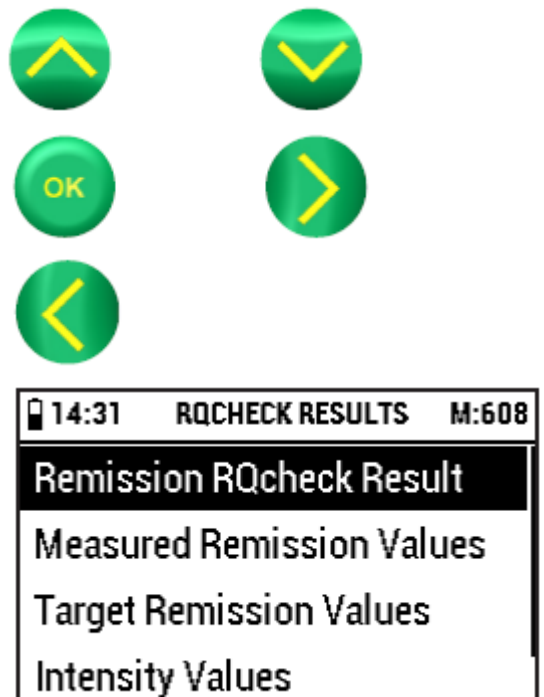

Select the desired RQcheck result detail using the [Up] and [Down] buttons:



Confirm your selection by pressing [OK] or [Right (Next)]



Pressing the [Left (Back)] button takes you back to [RQCHECK RESULTS].



The display shows the RQcheck result boxes:

Remission RQcheck Result:

14:42 RQCHECK RESULT M:608		
	Chan. 1	Chan. 2
Red	passed	passed
Green	passed	passed
Remission RQcheck Result		

Measured Remission Values:

14:45 RQCHECK RESULT M:608		
	Chan. 1	Chan. 2
Red	41.3%	41.7%
Green	40.5%	41.2%
Measured Remission Values		

Target Remission Values: (tolerance: ± 2.5 % remission)

13:30 RQCHECK RESULT M:608		
	Chan. 1	Chan. 2
Red	41.5%	41.5%
Green	42.5%	42.5%
Target Remission Values		

Intensity Values:

13:34 RQCHECK RESULT M:608		
	Chan. 1	Chan. 2
Red	02519	02563
Green	02527	02585
Intensity Values		

Pressing the [Left (Back)] button takes you back to [RQCHECK RESULTS].



For deletion the results of the chosen date, select [**X Delete RQcheck Result**] using the [Up] and [Down] buttons.



The display shows:

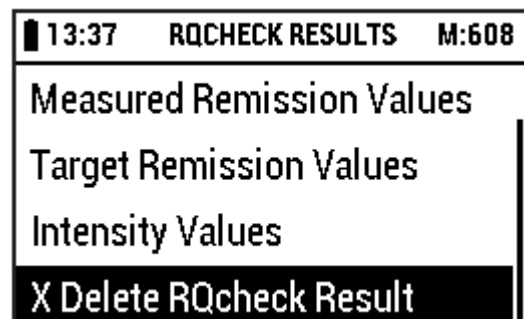

Confirm your selection by pressing [OK] or [Right (Next)].



The display shows:

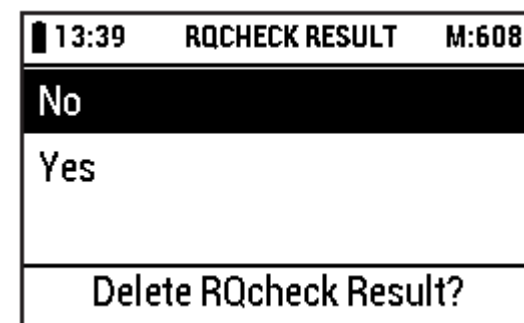

Select the desired action using the [Up] and [Down] buttons:



No: return to [**RQCHECK RESULTS**]

Yes: delete the RQcheck result and return to [**RQCHECK RESULTS**]

Confirm your selection by pressing [OK] or [Right (Next)].



6 System information

Switch on the reflectometer by pressing the [Power On/Off] button.



The unit runs an electronic self-check test.

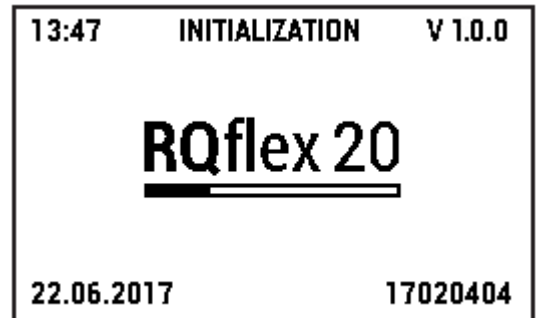

The display then shows the main menu:

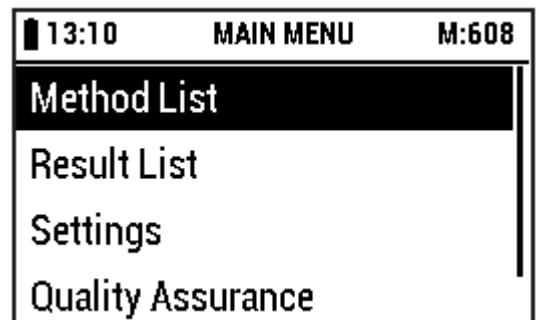

Select [**Information**] in the [**MAIN MENU**] using the [Up] and [Down] buttons.



The display shows:

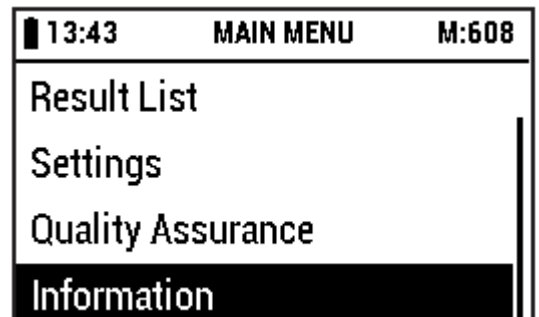

Confirm your selection by pressing [OK] or [Right (Next)].



The display shows information about

the software version of the instrument,
the free memory space of the instrument,
the battery condition of the instrument,
the serial number of the instrument,
the date,
and the time:

13:47	INFORMATION	M:608
Software Version		1.0.0
Free Memory		85%
Battery status		High
Serial Number		17020404

Pressing the [Left (Back)] or [Menu] button takes you back to **[MAIN MENU]**.



7 Maintenance of the instrument

To obtain consistently exact measurement results please follow these instructions for cleaning and maintenance.

7.1 Handling

Please treat this instrument with the same care as you do with all other electronic devices. Ensure that no liquid enters the instrument case, since this may result in damage that is not covered by the warranty.

Do not expose the instrument to excessively humid conditions or to excessive heat or cold (see section 9, **“Technical data”**).

If the external casing of the measurement instrument needs cleaning, please wipe the casing and the display carefully with a moist cloth.

Clean the optics and the strip adapter only with water and a mild detergent or ethanol (max.70% - v/v) on a tissue or cloth after dismantling the strip adapter (see section 7.2, **“Cleaning the strip adapter”**). Do not rinse the instrument or parts of it.



7.2 Cleaning the strip adapter

The strip adapter should be thoroughly cleaned (dismantling the strip adapter into its individual components) at the end of each working day. The strip adapter must be cleaned immediately if an error message („E07 + E10: Internal Standard out of range“ - see section 8, **“Troubleshooting”**) is displayed.

Clean the strip adapter only with water and a mild detergent or ethanol (max.70% - v/v) on a tissue or cloth after dismantling the strip adapter. Do not rinse the instrument or parts of it.

7.2.1 Procedure

Switch off the reflectometer by pressing the [Power On/Off] button.



Carefully pull the strip adapter out of the case.

Remove the upper part of the strip adapter from the lower part by easily sliding the components into opposite directions. Dismantle the adapter into its four components.

Clean the components with water and a mild detergent. If necessary, use ethanol (max.70% - v/v). Never clean the internal standard (light grey plastic component) with abrasive cleaner!

Dry the components carefully and reassemble the adapter.

Reinsert the adapter into the instrument.



8 Troubleshooting

The following tables show explanations of the error messages and tips on how to avoid incorrect measurements.

The most commonly encountered problems are caused by

- the test strips not being inserted correctly
- the reaction time of the strip not being right
- incorrect use of the tests (e.g. strips not properly stored, pH range not correctly adjusted).

8.1 User messages on the display

Display message	Possible causes	Remedy
W14: Low Battery! Replace Battery!	Battery state goes from Medium to Low or is at Low after Power Up. The Warning screen is displayed only once until the device is shutdown if the condition is met during all states except ongoing measurement	Replace battery
W15: Barcode not readable! Try again!	Barcode is spontaneously inserted from the user but could not be read error free	Try again to insert the barcode strip
W16: Barcode not readable! Try again!	Barcode is inserted after selecting 'Add new Method' in the Method List from the user but the code strip could not be read error free	Try again to insert the barcode strip
W17: Wrong Barcode inserted! Use a valid Barcode!	Barcode is inserted after selecting 'Add new Method' in the Method List or barcode is inserted in state 'Calibration Barcode' or barcode is inserted in state 'RQcheck' and read successfully but this barcode is invalid in the current state	Use a valid barcode strip
W18: Barcode not readable! Try again!	Barcode is inserted after selecting 'Add new Method' in the Method List, reading successfully the first barcode and then trying to read the second barcode but this barcode strip could not be successful read	Try again to insert the second barcode strip

Display message	Possible causes	Remedy
W19: Second Barcode not valid! Use a valid Barcode!	Wrong second barcode, invalid barcode (RQcheck, Calibration) inserted	Use a valid second barcode strip
W20: Barcode not readable! Try again!	Barcode is inserted after selecting 'Calibration' in menu Quality Assurance. The barcode strip could not be successfully read	Try again to insert the barcode strip
W21: Wrong Barcode! Use Calibration Barcode!	Barcode is inserted after selecting 'Calibration' in menu Quality Assurance .The barcode strip could be read but this was not a calibration barcode	Try again to insert the barcode strip for calibration
W22: Barcode not readable! Try again!	Barcode is inserted after selecting 'RQcheck' in menu Quality Assurance. The barcode strip could not be successfully read	Try again to insert the barcode strip
W23: Wrong Barcode! Use RQcheck Barcode!	Barcode is inserted after selecting 'RQcheck' in menu Quality Assurance. The barcode strip could be read but this was not a RQcheck barcode	Try again to insert the barcode strip for RQcheck
W24: Measurement Timeout! Start again!	Internal standard measurement was done but no measurement was started from the user for a time of > 60 minutes	Start the measurement again
W25: Calibration Timeout! Start again!	Internal standard measurement was done but no calibration measurement was started from the user for a time of > 60 minutes	Start the calibration again
W26: RQcheck Timeout! Start again!	Internal standard measurement was done but no RQcheck measurement was started from the user for a time of > 60 minutes	Start the RQcheck again
W27: Barcode reader test failed! Remove Barcode!	During system startup the barcode reader is tested .If a barcode or any other things was put into barcode or if a true error was detected, this warning text is shown in the display	Please remove barcode strip
W28: Default settings activated! Please check settings!	During system startup the instrument setting is checked. If the case of errors default settings are used	Check if the settings are correct
W29: Date/Time reset to default! Please check settings!	During system startup the instrument checks if the real time clock has lost its power and thus restarts date/time automatically from 2000.01.01 00:00:00	Check if the time settings are correct

Display message	Possible causes	Remedy
W30: Measurement not possible! Please calibrate and check device!	The user tries to execute a measurement in the case, the measurement is locked due to lost user calibration data.	Please calibrate and check device
W31: Measurement not possible! Please check device!	The user tries to execute a measurement in the case, the measurement is locked due fatal error, detected by the self tests	Please check device
W32: Measurement not possible! Please change batteries and try again!	The user tries to execute a measurement in the case, the measurement is locked due empty battery, detected by the VBAT monitoring	Please change batteries and try measurement again

8.2 Error messages

Display message	Possible causes	Remedy
E01: Selftest failed! Check device!	Selftest failed and measurement is locked. This error is detected in the case of fatal errors, when measurement is possible	Please check device
E02: Selftest failed! Switch off and check the device!	Selftest failed and the device is locked in the error screen. Only switch off will work!	Please switch off and check device
E03: Incorrect date! Correct the date!	The date was not correctly set	Please set the date correctly
E04: Memory write error! Operation is canceled. Try again!	Common Database write error - a transition to screen Main Menu takes place in the case of this error - regardless where this error happens	Please try again
E05: Memory read error! Operation is canceled. Try again!	Common Database read error - a transition to screen Main Menu takes place in the case of this error - regardless where this error happens	Please try again
E06: Measurement not possible! Remove strip and continue!	Internal standard measurement fails first time in a strip measurement procedure - the ongoing strip measurement proceeds.	Please remove the test strip and continue
E07: Internal Standard out of range! Clean optics!	Internal standard measurement fails twice in a strip measurement procedure - the ongoing strip measurement is aborted and the system is going to Method List	Please clean the optics (see section 7)

Display message	Possible causes	Remedy
E08: Measurement not possible! Repeat Measurement!	Range check failed or remission calculation failed - the ongoing strip measurement is aborted and the system is going to Method List	Please repeat the measurement
E09: RQcheck not possible! Remove strip and continue!	Internal standard measurement fails first time in a RQcheck measurement procedure - the ongoing strip measurement proceeds	Please remove the test strip and continue
E10: Internal Standard out of range! Clean optics!	Internal standard measurement fails twice in a strip measurement procedure - the ongoing strip measurement is aborted and the system is going back to "Insert a new RQcheck Barcode"	Please clean the optics (see section 7) and insert a new barcode strip
E11: RQcheck not possible! Repeat Measurement!	The ongoing RQcheck measurement is aborted and the system is going back to "Insert a new RQcheck Barcode"	Please insert a new RQcheck barcode strip and repeat the RQcheck measurement
E12: Calibration not possible! Repeat Measurement!	The ongoing calibration measurement is aborted and the system is going back to "Insert a new Calibration Barcode"	Please insert a new calibration barcode strip and repeat the calibration measurement
E13: Calibration failed! Repeat Calibration!	Range check failed or remission calculation failed. The ongoing strip measurement is aborted and the system is going back to Method List	Please repeat the calibration

8.3 Other faults

Problem

Display is frozen

Buttons/barcode reader do not respond

Remedy

Switch off the instrument by pressing buttons [Power On/Off], [Down], and [OK] successively or remove batteries, insert again and switch on anew or if the Auto Power Off is activated, the instrument switches off automatically after the defined time.

Switch off the instrument and start anew.

9 Technical data

Dimension:	184 x 79 x 30 mm
Weight:	253 g (including battery)
Memory:	50 test methods, 200 measurement results 50 RQcheck results, 50 calibration results
Interface:	yes (for technical service only)
Light source:	4 LEDs, green/red, double optics
Power source:	4 x 1.5-V batteries (AAA)
Display:	Reflective LCD Graphic Module (256x160 dot)
System diagnosis:	yes
Measurement range:	4 - 90 % rel.remission
Reflection area:	4 x 6 mm
Resolution:	0.1 % rel.remission
Operating temperature:	5 - 40 °C for ideal measurements
Operating humidity:	below 80 % for ideal measurements

10 Accessories

Reflectoquant® Strip adapter	1.16953.0001 Replacement part for Reflectometer
Reflectoquant® Recalibration Set	1.16954.0001 Replacement part for Reflectometer
Reflectoquant® RQcheck	1.17247.0001 Accessory for Reflectometer

11 Service / Warranty

Our instruments are 100% quality-controlled, which means that each individual instrument has been tested before leaving the factory. In addition to the described cleaning and calibration of Reflectometer, the device is maintenance-free. The detailed instruction should allow for problem-free operation.

In the event that you encounter an unsolvable problem, please contact the technical support specialist.

Warranty

The manufacturer grants for this Reflectometer a total replacement warranty of 12 months from the date of purchase.

All warranty work is provided by our customer service unit. In the event of a proven production or material defect, we will provide you with a new or as-new replacement Reflectometer free of charge.

Improper handling results in loss of warranty. No water or any other liquid must be allowed to enter the instrument. In such cases the warranty becomes invalid.

All warranty rights become invalid in the event that the purchaser or an unauthorized third person repairs or opens the instrument, or if changes are made to the warranty slip. Only the customer service unit is authorized to carry out maintenance on components.

If the instrument is sent in for repair under the terms of the warranty, a copy of the invoice or of another proof of purchase must be enclosed in all cases.

Postadress:

TRÄDGÅRDSTEKNIK AB
Helsingborgsvägen 578, Varalöv
262 96 ÄNGELHOLM

Telefon : 0431-222 90
Bg.nr : 5743-7980
Org.nr : 556409-6120

URL:

www.tradgardsteknik.se
E-postadress:
info@tradgardsteknik.se