

Electric Pressure Control Deluge Valve with EasyLock™ Manual Reset Model: FP 400E-2MC

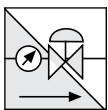

UL LISTED

Typical Applications



Fluctuating or over pressure

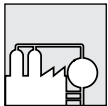

Petrochemical facilities

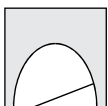

Tunnels

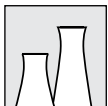

Power plants & transformers



Flammable materials storage



Aviation & airports

Features and Benefits

- **Pressure control function** – Constant preset downstream pressure
- **Latch open** – Closes upon local reset only
- **One-piece molded elastomeric moving part** – No maintenance required
- **Obstacle-free full bore** – Uncompromising reliability
- **Factory pre-assembled trim** – Out-of-box quality
- **In-line serviceable** – Minimal down time

Optional Features

- **Water motor alarm**
- **Alarm pressure-switch** (code: P or P7)
- **Explosion-proof for hazardous locations** (code: 7/8/9)
- **Hydraulic release** (requires trim extension)
- **Valve Position Single/Double Limit Switches**

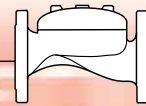

Operation

The BERMAD Model FP 400E-2MC is suitable for systems that include electric fire detection and a piping system with a wide variety of open nozzles. Combining a pressure control feature, the model FP 400E-2MC is recommended for systems with high pressure supply source and/or with relatively low flow.

In the SET position, the line-pressure supplied to both the main valve's control chamber [1] and to a Hydraulic Relay Valve (HRV) [2] via the priming line [3], and through a Check Valve [4], an Accelerator [5] with priming restriction, and an EasyLock Manual Reset [6] is trapped by the Check Valve, by the closed HRV, by a Solenoid Valve [7], and by a closed Manual Emergency Release [8]. The trapped pressure holds the main valve's diaphragm and plug against the valve seat [9], sealing it drip-tight and keeping the system piping dry.

Under FIRE condition, an electric signal triggers the Solenoid Valve to open, opening the HRV. Pressure is then released from the main valve's control chamber to the downstream, the open HRV and the Pressure Reducing (PR) Pilot valve [10]. The EasyLock prevents line-pressure from entering the HRV, allowing the main valve to latch open, and water to flow into the system piping and to the alarm device [11]. Should system pressure rise above PR pilot setting, the PR pilot throttles, thereby enabling pressure to accumulate in the valve control chamber. This causes the 400E-2MC to throttle closed, decreasing system pressure to PR pilot setting. The Manual Emergency Release [8], overrides the PR pilot, causing the FP 400E-2MC to open fully.

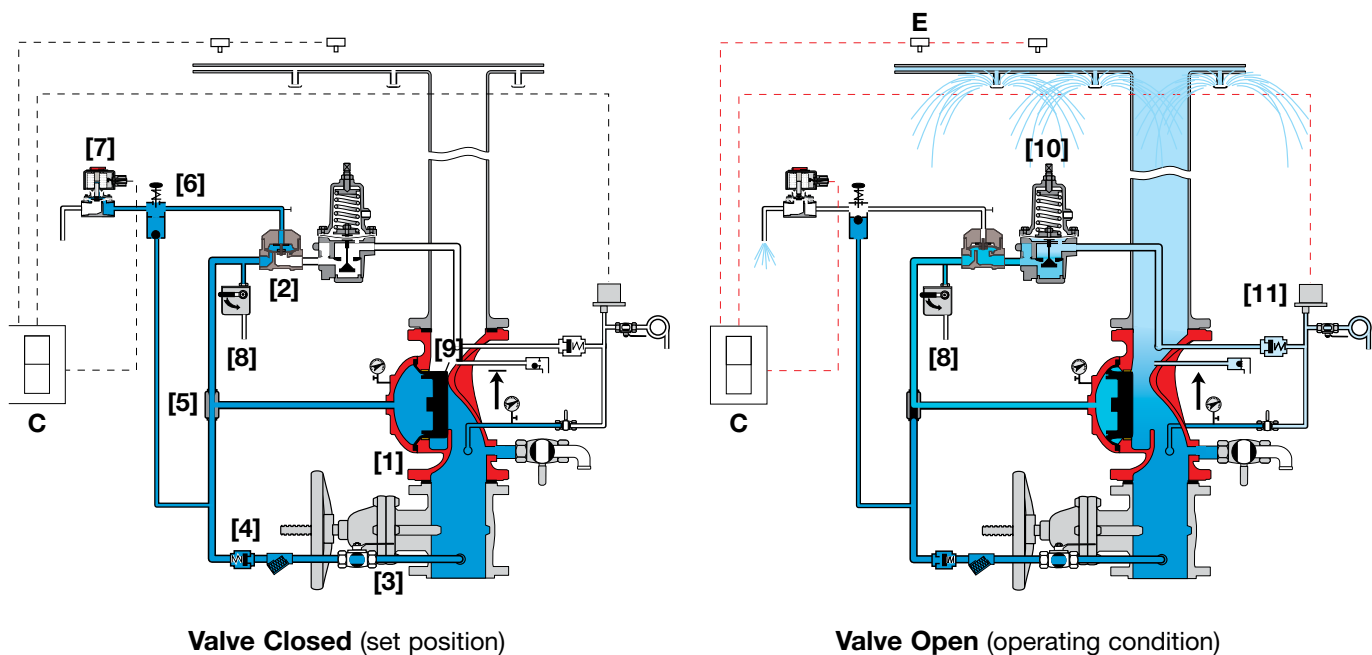

Valve Closed (set position)

Valve Open (operating condition)

Engineer Specifications

- The deluge valve shall be a UL-Listed, electrically controlled elastomeric type globe valve with a **rolling-diaphragm**.
- The valve shall have an **unobstructed flow path**, with no stem guide or **supporting ribs**.
- Valve actuation shall be accomplished by a fully peripherally supported, one-piece balanced rolling-diaphragm, vulcanized with a rugged radial seal disk. The diaphragm assembly shall be the only moving part.
- The valve shall have a removable cover for quick in-line service enabling all necessary inspection and servicing.
- The control trim materials shall consist of St.St. 316 tubing and fittings, and plated brass accessories, including local **EasyLock** Manual Reset, 2-way Solenoid Pilot Valve, Y strainer and Manual Emergency Release.
- The control trim shall be supplied as an assembly, pre-assembled and hydraulically tested at an ISO 9000 and 9001 certified factory.
- The Pressure Control and Electrically Controlled Deluge Valve shall latch open in response to activation of the solenoid, reducing higher upstream pressure to lower preset downstream pressure. The valve shall reset to the closed position only upon local manual activation of the reset device.

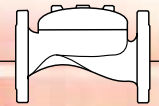

System Components

- 1 - Main Valve, BERMAD FP 400E Series
- 2A - Gauge Valve
- 2B - Accelerator with Priming Restriction
- 2R - Pressure Reducing Pilot
- 3A - Pressure Gauge (3 units)
- 4B - Priming Strainer
- 5A - Drain Valve
- 7B - Check Valve
- 11A - Alarm Shutoff Valve
- 14A - Check Valve
- 14B - Solenoid Valve
- 15B - Manual Emergency Release
- 18B - Priming Ball Valve
- 19B - Drip Check
- 26B - Hydraulic Relay Valve (HRV)
- M - EasyLock Manual Reset

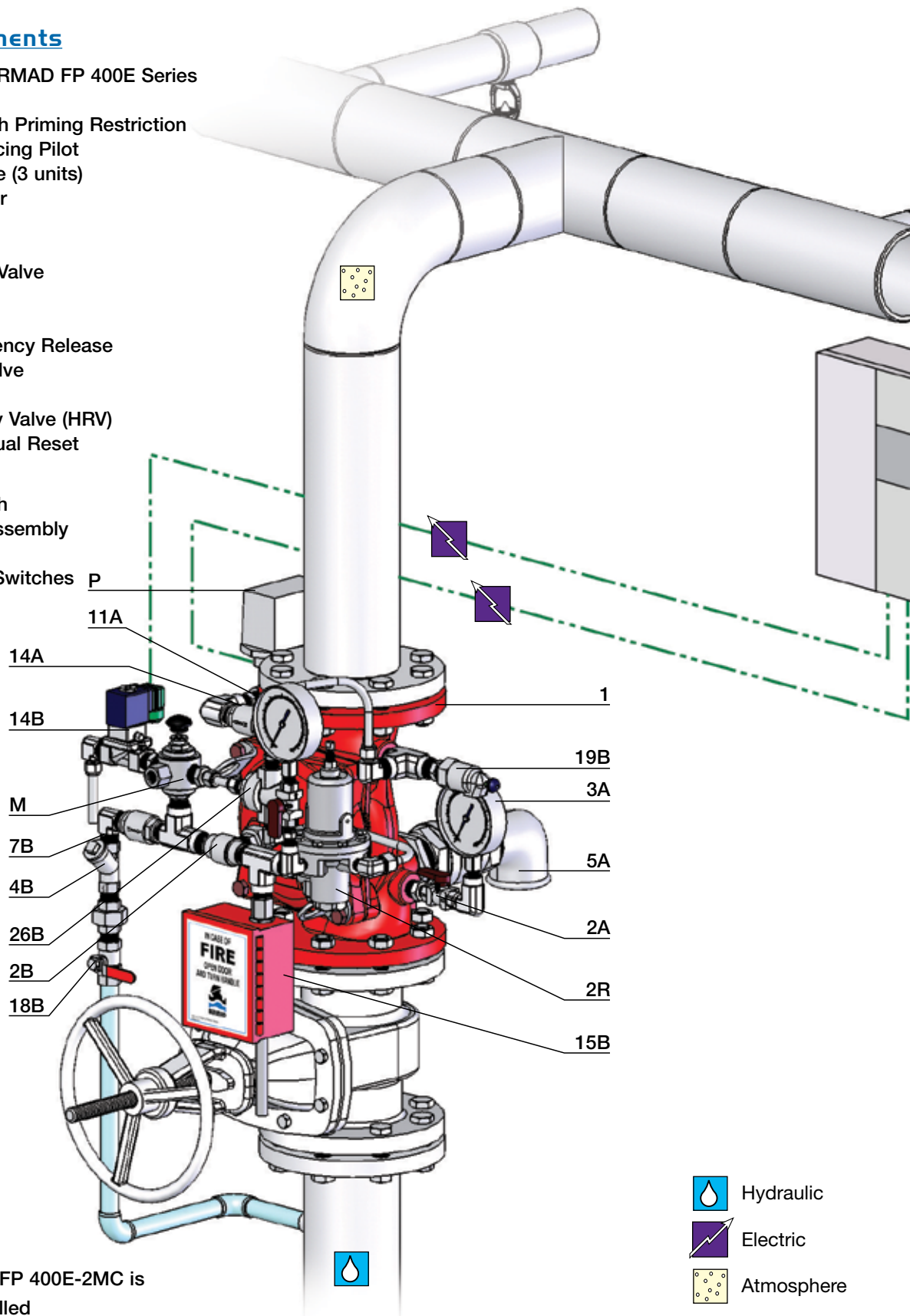

Optional

- P - Pressure Switch
- W - Water Motor Assembly
- S - Valve Position Limit Switch / Switches



UL Listed

The BERMAD Model FP 400E-2MC is UL-Listed when installed with specific components and accessories.

-  Hydraulic
-  Electric
-  Atmosphere

BERMAD Fire Protection

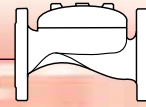

Model: FP 400E-2MC

400 Series

Technical Data

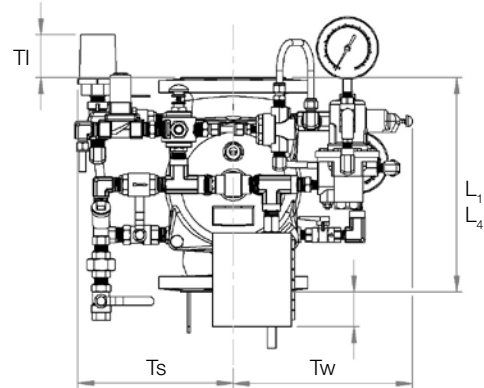
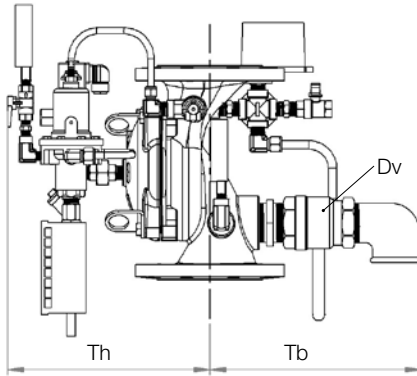

Size	1½", 2"		2½"		3"		4"		6"		8"		10"		12"		
	mm	inch	mm	inch	mm	inch	mm	inch	mm	inch	mm	inch	mm	inch	mm	inch	
Dimensions	L ₁ ⁽¹⁾	205	8 1/16	205	8 1/16	257	10 1/8	320	12 5/8	415	16 5/16	500	19 11/16	605	23 13/16	725	28 9/16
	L ₄ ⁽²⁾	205	8 1/16	N/A	N/A	250	9 13/16	320	12 5/8	415	16 5/16	500	19 11/16	N/A	N/A	N/A	N/A
	TI	142	5 5/8	142	5 5/8	119	4 11/16	84	3 5/16	57	2 1/4	-	-	-	-	-	-
	Tw	228	9	220	8 11/16	243	9 9/16	253	10	312	12 5/16	326	12 13/16	346	13 5/8	391	15 3/8
	Ts	228	9	220	8 11/16	243	9 9/16	253	10	318	12 1/2	326	12 13/16	326	12 13/16	391	15 3/8
	Th	226	8 7/8	242	9 1/2	262	10 5/16	261	10 5/16	356	14	407	16	407	16	546	21 1/2
	Tb	278	10 1/16	289	11 3/8	300	11 13/16	337	13 1/4	378	14 7/8	405	15 15/16	413	16 1/4	473	18 5/8
	Dv Ø	¾"		1 1/2"		1 1/2"		2"		2"		2"		2"		2"	

Notes:

- L₁ is for flanged ANSI #150 and ISO PN16.
- L₄ is for grooved end connections (Ductile Iron Only).
- Provide adequate space around valve for maintenance.
- Data is for envelope dimensions, specific component positioning may vary.

Connection Standard

- Flanged: ANSI B16.42 (Ductile Iron), B16.5 (Steel & Stainless Steel), B16.24 (Bronze) or ISO PN16
- Grooved: ANSI/AWWA C606 for 2, 3, 4, 6 & 8"

Water Temperature

- 0.5 – 50°C (33 – 122°F)

Available Sizes

- 1½, 2, 2½, 3, 4, 6, 8, 10 & 12"
- UL-Listed for sizes 1½, 2, 2½, 3, 4, 6, 8 & 10"

Pressure Rating*

- Max. inlet: 250 psi (17 bar)
- Set: 30-165 psi (4.5-11.5 bar)

* Pressure rating might be limited due to solenoid valve rating

Manufacturers Standard Materials

Main valve body and cover

- Ductile Iron ASTM A-536

Main valve internals

- Stainless Steel 304 & Cast Iron

Control Trim System

- Brass control components/accessories
- Forged Brass pressure reducing pilot with St. St. 304 internals & NBR elastomers

elastomers

- Stainless Steel 316 tubing & fittings

Elastomers

- Nylon fabric reinforced polyisoprene NR

Coating

- Electrostatic Powder Coating Polyester, Red (RAL 3002)

Optional Materials

Main valve body

- Carbon Steel ASTM A-216 WCB
- Stainless Steel 316
- Ni-Al-Bronze ASTM B-148

Control Trim

- Stainless Steel 316
- Monel® and Ni-Al-Bronze
- Hastalloy C-276

Elastomers

- NBR
- EPDM

Coating

- High Build Epoxy Fusion-Bonded with UV Protection, Anti-Corrosion

Valve Outlet Pressure Fall-off Characteristics On Inlet Under Set Pressure

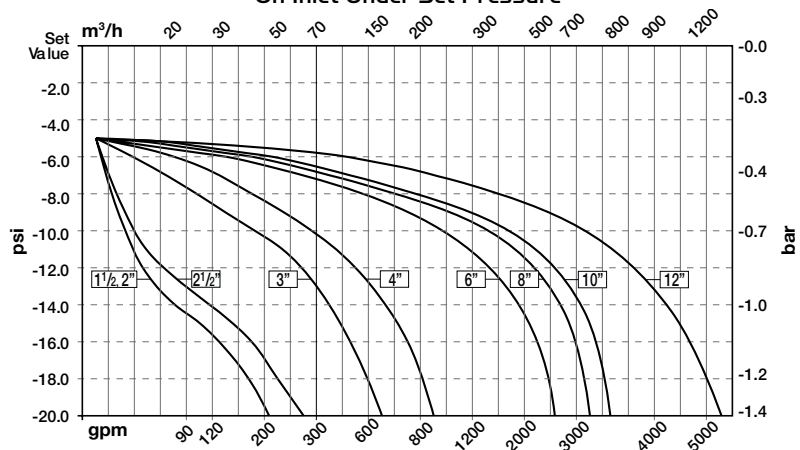

Solenoid Pilot Valves

Standard

- 2-way Pilot Operated type
- Brass body
- Main valve closed when de-energized
- Enclosure: General purpose watertight, NEMA 4 and 4X / IP65, Class F
- Power: 24VDC, 8 watts
- UL - Listed

Options (see also ordering guide)

- Hazardous locations:
 - Class I Division 1, Gr. A, B, C, D, T4 (code 7)
 - ATEX, EEx em IIC T4 (code 8)
 - ATEX, EEx d IIC T4/5 (code 9)
- Voltage: see ordering guide (voltage option table)
- Stainless steel 316 body material (code K)



Trädgårdsteknik AB
Helsingborgsvägen 578
262 96 ÄNGELHOLM
Telefon: 0431-222 90
Telefax: 0431-222 70
info@tradgardsteknik.se
www.tradgardsteknik.se
